

KERRISON

Punch, regular handle, 9.5mm opening

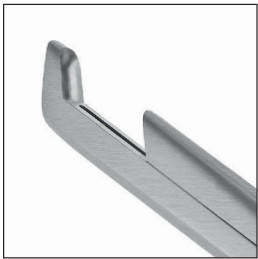

40° upwards cutting
180mm, 7"

1mm	250-400-181
2mm	250-400-182
3mm	250-400-183
4mm	250-400-184
5mm	250-400-185
6mm	250-400-186

200mm, 8"

1mm	250-400-201
2mm	250-400-202
3mm	250-400-203
4mm	250-400-204
5mm	250-400-205
6mm	250-400-206

230mm, 9"

1mm	250-400-231
2mm	250-400-232
3mm	250-400-233
4mm	250-400-234
5mm	250-400-235
6mm	250-400-236

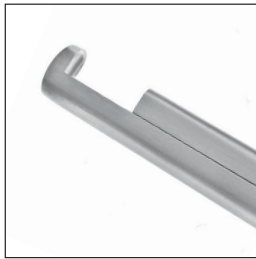

90° upwards cutting
180mm, 7"

1mm	250-410-181
2mm	250-410-182
3mm	250-410-183
4mm	250-410-184
5mm	250-410-185
6mm	250-410-186

200mm, 8"

1mm	250-410-201
2mm	250-410-202
3mm	250-410-203
4mm	250-410-204
5mm	250-410-205
6mm	250-410-206

230mm, 9"

1mm	250-410-231
2mm	250-410-232
3mm	250-410-233
4mm	250-410-234
5mm	250-410-235
6mm	250-410-236



40° downwards cutting
180mm, 7"

1mm	250-420-181
2mm	250-420-182
3mm	250-420-183
4mm	250-420-184
5mm	250-420-185
6mm	250-420-186

200mm, 8"

1mm	250-420-201
2mm	250-420-202
3mm	250-420-203
4mm	250-420-204
5mm	250-420-205
6mm	250-420-206

230mm, 9"

1mm	250-420-231
2mm	250-420-232
3mm	250-420-233
4mm	250-420-234
5mm	250-420-235
6mm	250-420-236



90° downwards cutting
180mm, 7"

1mm	250-430-181
2mm	250-430-182
3mm	250-430-183
4mm	250-430-184
5mm	250-430-185
6mm	250-430-186

200mm, 8"

1mm	250-430-201
2mm	250-430-202
3mm	250-430-203
4mm	250-430-204
5mm	250-430-205
6mm	250-430-206

230mm, 9"

1mm	250-430-231
2mm	250-430-232
3mm	250-430-233
4mm	250-430-234
5mm	250-430-235
6mm	250-430-236

All Kerrison instruments are available with CERACUT® coating. Code number + CC (e.g. 250-400-181CC)





KERRISON

Punch, large handle,
15.5mm opening

40° upwards cutting
180mm, 7"

1mm	250-450-181
2mm	250-450-182
3mm	250-450-183
4mm	250-450-184
5mm	250-450-185
6mm	250-450-186

200mm, 8"

1mm	250-450-201
2mm	250-450-202
3mm	250-450-203
4mm	250-450-204
5mm	250-450-205
6mm	250-450-206

230mm, 9"

1mm	250-450-231
2mm	250-450-232
3mm	250-450-233
4mm	250-450-234
5mm	250-450-235
6mm	250-450-236

90° upwards cutting
180mm, 7"

1mm	250-460-181
2mm	250-460-182
3mm	250-460-183
4mm	250-460-184
5mm	250-460-185
6mm	250-460-186

200mm, 8"

1mm	250-460-201
2mm	250-460-202
3mm	250-460-203
4mm	250-460-204
5mm	250-460-205
6mm	250-460-206

230mm, 9"

1mm	250-460-231
2mm	250-460-232
3mm	250-460-233
4mm	250-460-234
5mm	250-460-235
6mm	250-460-236

40° downwards cutting
180mm, 7"

1mm	250-470-181
2mm	250-470-182
3mm	250-470-183
4mm	250-470-184
5mm	250-470-185
6mm	250-470-186

200mm, 8"

1mm	250-470-201
2mm	250-470-202
3mm	250-470-203
4mm	250-470-204
5mm	250-470-205
6mm	250-470-206

230mm, 9"

1mm	250-470-231
2mm	250-470-232
3mm	250-470-233
4mm	250-470-234
5mm	250-470-235
6mm	250-470-236

90° downwards cutting
180mm, 7"

1mm	250-480-181
2mm	250-480-182
3mm	250-480-183
4mm	250-480-184
5mm	250-480-185
6mm	250-480-186

200mm, 8"

1mm	250-480-201
2mm	250-480-202
3mm	250-480-203
4mm	250-480-204
5mm	250-480-205
6mm	250-480-206

230mm, 9"

1mm	250-480-231
2mm	250-480-232
3mm	250-480-233
4mm	250-480-234
5mm	250-480-235
6mm	250-480-236

All Kerrison instruments are available with CERACUT® coating. Code number + CC (e.g. 250-400-181CC)



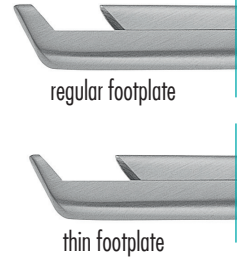
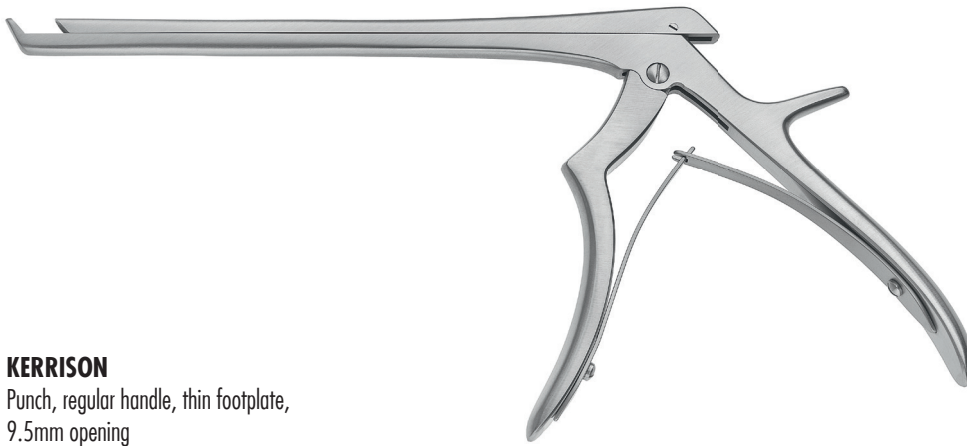

KERRISON

Punch, regular handle, thin footplate,
9.5mm opening

40° upwards cutting
180mm, 7"

1mm	250-401-181
2mm	250-401-182
3mm	250-401-183
4mm	250-401-184
5mm	250-401-185

200mm, 8"

1mm	250-401-201
2mm	250-401-202
3mm	250-401-203
4mm	250-401-204
5mm	250-401-205

230mm, 9"

1mm	250-401-231
2mm	250-401-232
3mm	250-401-233
4mm	250-401-234
5mm	250-401-235

90° upwards cutting
180mm, 7"

1mm	250-411-181
2mm	250-411-182
3mm	250-411-183
4mm	250-411-184
5mm	250-411-185

200mm, 8"

1mm	250-411-201
2mm	250-411-202
3mm	250-411-203
4mm	250-411-204
5mm	250-411-205

230mm, 9"

1mm	250-411-231
2mm	250-411-231
3mm	250-411-231
4mm	250-411-231
5mm	250-411-231

40° downwards cutting
180mm, 7"

1mm	250-421-181
2mm	250-421-182
3mm	250-421-183
4mm	250-421-184
5mm	250-421-185

200mm, 8"

1mm	250-421-201
2mm	250-421-202
3mm	250-421-203
4mm	250-421-204
5mm	250-421-205

230mm, 9"

1mm	250-421-231
2mm	250-421-231
3mm	250-421-231
4mm	250-421-231
5mm	250-421-231

90° downwards cutting
180mm, 7"

1mm	250-431-181
2mm	250-431-182
3mm	250-431-183
4mm	250-431-184
5mm	250-431-185

200mm, 8"

1mm	250-431-201
2mm	250-431-202
3mm	250-431-203
4mm	250-431-204
5mm	250-431-205

230mm, 9"

1mm	250-431-231
2mm	250-431-231
3mm	250-431-231
4mm	250-431-231
5mm	250-431-231

All Kerrison instruments are available with CERACUT® coating. Code number + CC (e.g. 250-400-181CC)





KERRISON

Punch, regular handle, superflat footplate



180mm, 7"
40° upwards cutting

1mm	250-400-181SF
1.5mm	250-400-189SF
2mm	250-400-182SF
3mm	250-400-183SF
4mm	250-400-184SF
5mm	250-400-185SF
6mm	250-400-186SF

180mm, 7"
40° upwards cutting,
standard ejector

2mm	250-400-182ESF
3mm	250-400-183ESF
4mm	250-400-184ESF
5mm	250-400-185ESF
6mm	250-400-186ESF

180mm, 7"
40° upwards cutting, CERA-CUT®

1mm	250-400-181SFCC
2mm	250-400-182SFCC
3mm	250-400-183SFCC
4mm	250-400-184SFCC
5mm	250-400-185SFCC
6mm	250-400-186SFCC

200mm, 8"

1mm	250-400-201SF
1.5mm	250-400-209SF
2mm	250-400-202SF
3mm	250-400-203SF
4mm	250-400-204SF
5mm	250-400-205SF
6mm	250-400-206SF

200mm, 8"

2mm	250-400-202ESF
3mm	250-400-203ESF
4mm	250-400-204ESF
5mm	250-400-205ESF
6mm	250-400-206ESF

200mm, 8"

1mm	250-400-201SFCC
2mm	250-400-202SFCC
3mm	250-400-203SFCC
4mm	250-400-204SFCC
5mm	250-400-205SFCC
6mm	250-400-206SFCC

230mm, 9"

1mm	250-400-231SF
1.5mm	250-400-239SF
2mm	250-400-232SF
3mm	250-400-233SF
4mm	250-400-234SF
5mm	250-400-235SF
6mm	250-400-236SF

230mm, 9"

2mm	250-400-232ESF
3mm	250-400-233ESF
4mm	250-400-234ESF
5mm	250-400-235ESF
6mm	250-400-236ESF

230mm, 9"

1mm	250-400-231SFCC
2mm	250-400-232SFCC
3mm	250-400-233SFCC
4mm	250-400-234SFCC
5mm	250-400-235SFCC
6mm	250-400-236SFCC

All Kerrison instruments are available with CERACUT® coating. Code number + CC (e.g. 250-400-181CC)





KERRISON

Punch, regular handle, superflat footplate

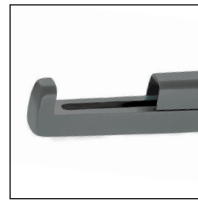

180mm, 7"
90° upwards cutting

1mm	250-411-181SF
2mm	250-411-182SF
3mm	250-411-183SF
4mm	250-411-184SF
5mm	250-411-185SF
6mm	250-411-186SF

180mm, 7"
90° upwards cutting,
standard ejector

2mm	250-411-182ESF
3mm	250-411-183ESF
4mm	250-411-184ESF
5mm	250-411-185ESF
6mm	250-411-186ESF

180mm, 7"
90° upwards cutting, CERA-CUT®

1mm	250-411-181SFCC
2mm	250-411-182SFCC
3mm	250-411-183SFCC
4mm	250-411-184SFCC
5mm	250-411-185SFCC
6mm	250-411-186SFCC

200mm, 8"

1mm	250-411-201SF
2mm	250-411-202SF
3mm	250-411-203SF
4mm	250-411-204SF
5mm	250-411-205SF
6mm	250-411-206SF

200mm, 8"

2mm	250-411-202ESF
3mm	250-411-203ESF
4mm	250-411-204ESF
5mm	250-411-205ESF
6mm	250-411-206ESF

200mm, 8"

1mm	250-411-201SFCC
2mm	250-411-202SFCC
3mm	250-411-203SFCC
4mm	250-411-204SFCC
5mm	250-411-205SFCC
6mm	250-411-206SFCC

230mm, 9"

1mm	250-411-231SF
2mm	250-411-232SF
3mm	250-411-233SF
4mm	250-411-234SF
5mm	250-411-235SF
6mm	250-411-236SF

230mm, 9"

2mm	250-411-232ESF
3mm	250-411-233ESF
4mm	250-411-234ESF
5mm	250-411-235ESF
6mm	250-411-236ESF

230mm, 9"

1mm	250-411-231SFCC
2mm	250-411-232SFCC
3mm	250-411-233SFCC
4mm	250-411-234SFCC
5mm	250-411-235SFCC
6mm	250-411-236SFCC

All Kerrison instruments are available with CERACUT® coating. Code number + CC (e.g. 250-400-181CC)





KERRISON

Long Anterior Punch, regular handle,
9.5mm opening,
40° upwards cutting

250mm, 9 ⁷ / ₈ "	
2mm	250-400-252
3mm	250-400-253
4mm	250-400-254
5mm	250-400-255
6mm	250-400-256

280mm, 11"	
2mm	250-400-282
3mm	250-400-283
4mm	250-400-284
5mm	250-400-285
6mm	250-400-286

15.5mm opening,
40° upwards cutting

250mm, 9 ⁷ / ₈ "	
2mm	250-450-252
3mm	250-450-253
4mm	250-450-254
5mm	250-450-255
6mm	250-450-256

280mm, 11"	
2mm	250-450-282
3mm	250-450-283
4mm	250-450-284
5mm	250-450-285
6mm	250-450-286

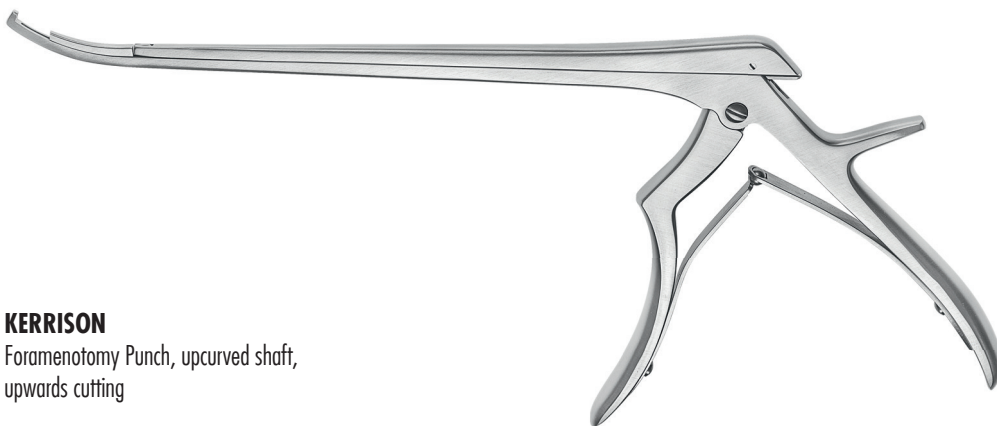

KERRISON

Foramenotomy Punch, upcurved shaft,
upwards cutting

180mm, 7"	
2mm	210-728-002
3mm	210-728-003
4mm	210-728-004

200mm, 8"	
2mm	210-728-102
3mm	210-728-103
4mm	210-728-104

All Kerrison instruments are available with CERACUT® coating. Code number + CC (e.g. 250-400-181CC)



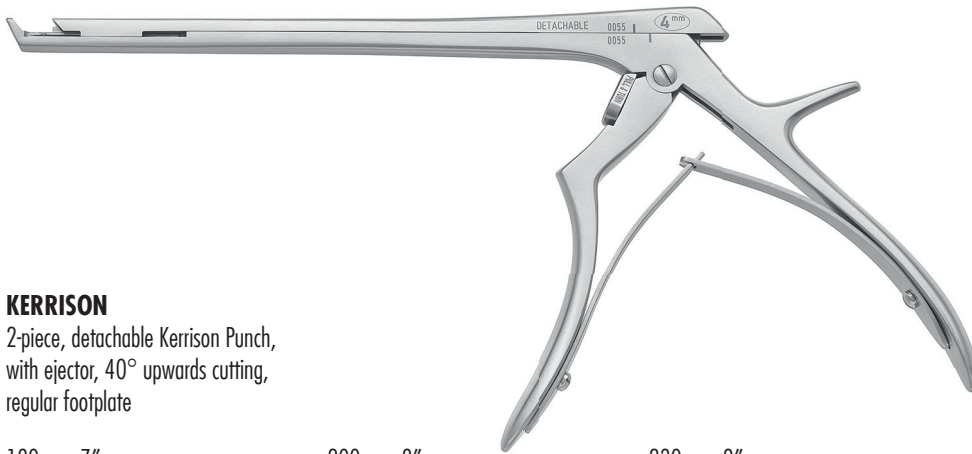
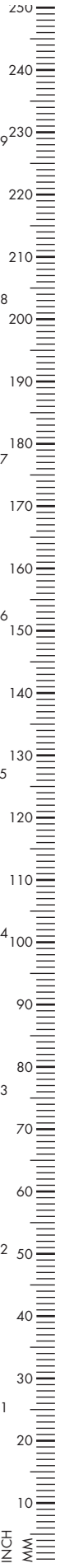

KERRISON

2-piece, detachable Kerrison Punch, with ejector, 40° upwards cutting, regular footplate

180mm, 7"		200mm, 8"		230mm, 9"	
1mm	250-500-181	1mm	250-500-201	1mm	250-500-231
2mm	250-500-182	2mm	250-500-202	2mm	250-500-232
3mm	250-500-183	3mm	250-500-203	3mm	250-500-233
4mm	250-500-184	4mm	250-500-204	4mm	250-500-234
5mm	250-500-185	5mm	250-500-205	5mm	250-500-235
6mm	250-500-186	6mm	250-500-206	6mm	250-500-236
thin footplate 180mm, 7"		thin footplate 200mm, 8"		thin footplate 230mm, 9"	
1mm	250-510-181	1mm	250-510-201	1mm	250-510-231
2mm	250-510-182	2mm	250-510-202	2mm	250-510-232
3mm	250-510-183	3mm	250-510-203	3mm	250-510-233
4mm	250-510-184	4mm	250-510-204	4mm	250-510-234

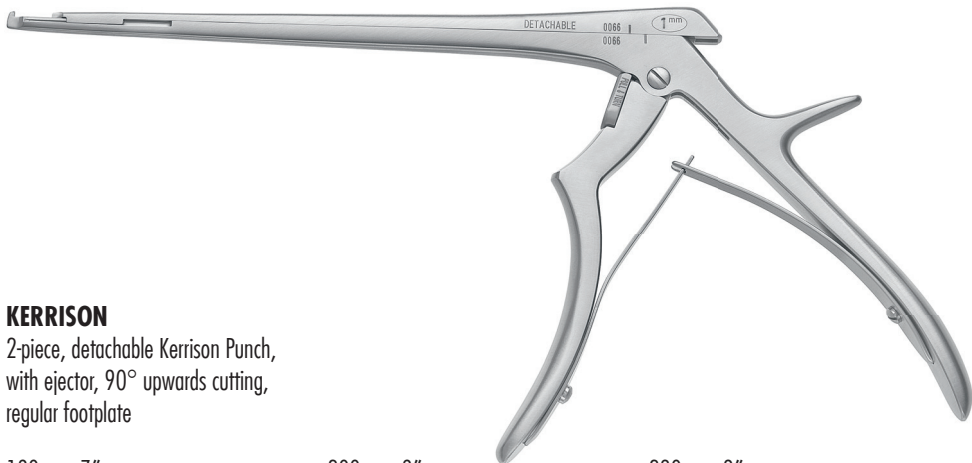

KERRISON

2-piece, detachable Kerrison Punch, with ejector, 90° upwards cutting, regular footplate

180mm, 7"		200mm, 8"		230mm, 9"	
1mm	250-590-181	1mm	250-590-201	1mm	250-590-231
2mm	250-590-182	2mm	250-590-202	2mm	250-590-232
3mm	250-590-183	3mm	250-590-203	3mm	250-590-233
4mm	250-590-184	4mm	250-590-204	4mm	250-590-234
5mm	250-590-185	5mm	250-590-205	5mm	250-590-235
6mm	250-590-186	6mm	250-590-206	6mm	250-590-236

All Kerrison instruments are available with CERACUT® coating. Code number + CC (e.g. 250-400-181CC)



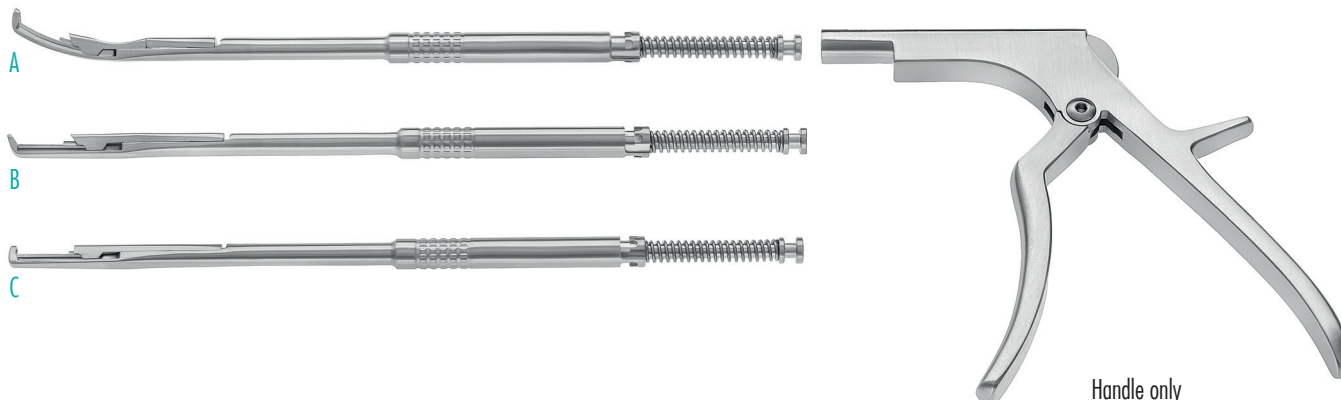

Handle only
250-245-000

A 360° Foraminotomy Punch
exchangeable shaft, ejector, thin footplate
40° angled

180mm, 7"		200mm, 8"		230mm, 9"		250mm, 9 ⁷ / ₈ "	
2mm	250-280-182	2mm	250-280-202	2mm	250-280-232	2mm	250-280-252
3mm	250-280-183	3mm	250-280-203	3mm	250-280-233	3mm	250-280-253
4mm	250-280-184	4mm	250-280-204	4mm	250-280-234	4mm	250-280-254
5mm	250-280-185	5mm	250-280-205	5mm	250-280-235	5mm	250-280-255

B 360° Laminectomy Punch
exchangeable shaft, ejector, thin footplate
40° angled

180mm, 7"		200mm, 8"		230mm, 9"		250mm, 9 ⁷ / ₈ "	
1mm	250-210-181	1mm	250-210-201	1mm	250-210-231	1mm	250-210-251
1.5mm	250-210-180	1.5mm	250-210-200	2mm	250-210-232	2mm	250-210-252
2mm	250-210-182	2mm	250-210-202	3mm	250-210-233	3mm	250-210-253
3mm	250-210-138	3mm	250-210-203	4mm	250-210-234	4mm	250-210-254
4mm	250-210-183	4mm	250-210-204	5mm	250-210-235	5mm	250-210-255
5mm	250-210-185	5mm	250-210-205				

C 360° Laminectomy Punch
exchangeable shaft, ejector, thin footplate
90° angled

180mm, 7"		200mm, 8"		230mm, 9"		250mm, 9 ⁷ / ₈ "	
1mm	250-245-181	1mm	250-245-201	1mm	250-245-231	1mm	250-245-251
1.5mm	250-245-180	1.5mm	250-245-200	2mm	250-245-232	2mm	250-245-252
2mm	250-245-182	2mm	250-245-202	3mm	250-245-233	3mm	250-245-253
3mm	250-245-183	3mm	250-245-203	4mm	250-245-234	4mm	250-245-254
4mm	250-245-184	4mm	250-245-204	5mm	250-245-235	5mm	250-245-255
5mm	250-245-185	5mm	250-245-205				

All Kerrison instruments are available with CERACUT® coating. Code number + CC (e.g. 250-400-181CC)



KERRISON
Kerrison Swivel Punch
2-piece detachable punch

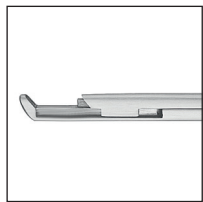

Regular footplate
40° upwards cutting

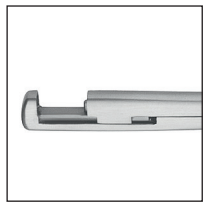

Regular footplate
90° upwards cutting



Regular footplate
40° downwards cutting

180mm, 7"		200mm, 8"		230mm, 9"	
1mm	250-600-181	1mm	250-600-201	1mm	250-600-231
2mm	250-600-182	2mm	250-600-202	2mm	250-600-232
3mm	250-600-183	3mm	250-600-203	3mm	250-600-233
4mm	250-600-184	4mm	250-600-204	4mm	250-600-234
5mm	250-600-185	5mm	250-600-205	5mm	250-600-235
6mm	250-600-186	6mm	250-600-206	6mm	250-600-236

180mm, 7"		200mm, 8"		230mm, 9"	
1mm	250-640-181	1mm	250-640-201	1mm	250-640-231
2mm	250-640-182	2mm	250-640-202	2mm	250-640-232
3mm	250-640-183	3mm	250-640-203	3mm	250-640-233
4mm	250-640-184	4mm	250-640-204	4mm	250-640-234
5mm	250-640-185	5mm	250-640-205	5mm	250-640-235
6mm	250-640-186	6mm	250-640-206	6mm	250-640-236

180mm, 7"		200mm, 8"		230mm, 9"	
1mm	250-630-181	1mm	250-630-201	1mm	250-630-231
2mm	250-630-182	2mm	250-630-202	2mm	250-630-232
3mm	250-630-183	3mm	250-630-203	3mm	250-630-233
4mm	250-630-184	4mm	250-630-204	4mm	250-630-234
5mm	250-630-185	5mm	250-630-205	5mm	250-630-235
6mm	250-630-186	6mm	250-630-206	6mm	250-630-236

All instruments are available with CERACUT® coating. Code number + CC (e.g. 250-600-181CC)



KERRISON
Kerrison Swivel Punch
2-piece detachable punch

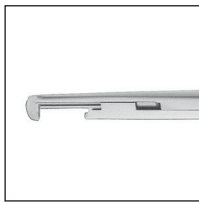

Regular footplate
90° downwards cutting

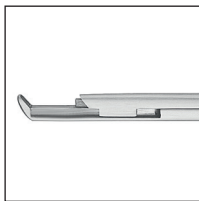

Thin footplate
40° upwards cutting

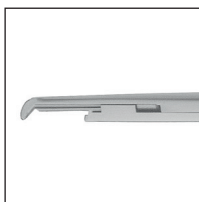

Thin footplate
40° downwards cutting



Foramenotomy
40° upwards cutting

180mm, 7"	
1mm	250-660-181
2mm	250-660-182
3mm	250-660-183
4mm	250-660-184
5mm	250-660-185
6mm	250-660-186

200mm, 8"	
1mm	250-660-201
2mm	250-660-202
3mm	250-660-203
4mm	250-660-204
5mm	250-660-205
6mm	250-660-206

230mm, 9"	
1mm	250-660-231
2mm	250-660-232
3mm	250-660-233
4mm	250-660-234
5mm	250-660-235
6mm	250-660-236

180mm, 7"	
1mm	250-610-181
2mm	250-610-182
3mm	250-610-183
4mm	250-610-184
5mm	250-610-185
6mm	250-610-186

200mm, 8"	
1mm	250-610-201
2mm	250-610-202
3mm	250-610-203
4mm	250-610-204
5mm	250-610-205
6mm	250-610-206

230mm, 9"	
1mm	250-610-231
2mm	250-610-232
3mm	250-610-233
4mm	250-610-234
5mm	250-610-235
6mm	250-610-236

180mm, 7"	
1mm	250-620-181
2mm	250-620-182
3mm	250-620-183
4mm	250-620-184
5mm	250-620-185
6mm	250-620-186

200mm, 8"	
1mm	250-620-201
2mm	250-620-202
3mm	250-620-203
4mm	250-620-204
5mm	250-620-205
6mm	250-620-206

230mm, 9"	
1mm	250-620-231
2mm	250-620-232
3mm	250-620-233
4mm	250-620-234
5mm	250-620-235
6mm	250-620-236

180mm, 7"	
1mm	250-680-181
2mm	250-680-182
3mm	250-680-183
4mm	250-680-184
5mm	250-680-185
6mm	250-680-186

200mm, 8"	
1mm	250-680-201
2mm	250-680-202
3mm	250-680-203
4mm	250-680-204
5mm	250-680-205
6mm	250-680-206

All instruments are available with CERACUT® coating. Code number + CC (e.g. 250-600-181CC)



KERRISON
Kerrison Swivel Punch
bayonet shaped shaft
2-piece detachable punch

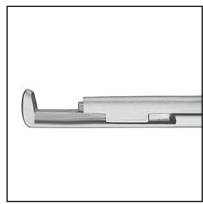
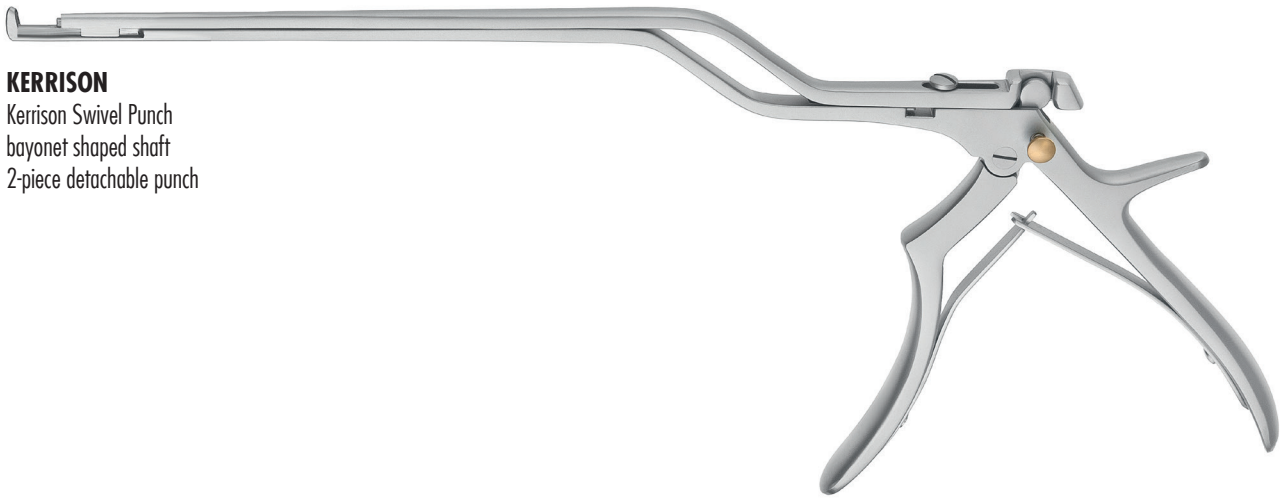

90° upwards cutting



90° upwards cutting
left curved jaw

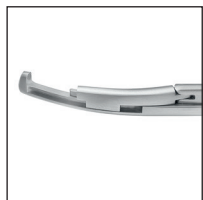

90° upwards cutting
right curved jaw

180mm, 7"

1mm	250-650-111
2mm	250-650-112
3mm	250-650-113
4mm	250-650-114
5mm	250-650-115
6mm	250-650-116

200mm, 8"

1mm	250-650-151
2mm	250-650-152
3mm	250-650-153
4mm	250-650-154
5mm	250-650-155
6mm	250-650-156

230mm, 9"

1mm	250-650-181
2mm	250-650-182
3mm	250-650-183
4mm	250-650-184
5mm	250-650-185
6mm	250-650-186

180mm, 7"

1mm	250-651-111
2mm	250-651-112
3mm	250-651-113
4mm	250-651-114
5mm	250-651-115
6mm	250-651-116

200mm, 8"

1mm	250-651-151
2mm	250-651-152
3mm	250-651-153
4mm	250-651-154
5mm	250-651-155
6mm	250-651-156

230mm, 9"

1mm	250-651-181
2mm	250-651-182
3mm	250-651-183
4mm	250-651-184
5mm	250-651-185
6mm	250-651-186

180mm, 7"

1mm	250-652-111
2mm	250-652-112
3mm	250-652-113
4mm	250-652-114
5mm	250-652-115
6mm	250-652-116

200mm, 8"

1mm	250-652-151
2mm	250-652-152
3mm	250-652-153
4mm	250-652-154
5mm	250-652-155
6mm	250-652-156

230mm, 9"

1mm	250-652-181
2mm	250-652-182
3mm	250-652-183
4mm	250-652-184
5mm	250-652-185
6mm	250-652-186

All instruments are available with CERACUT® coating. Code number + CC (e.g. 250-600-181CC)



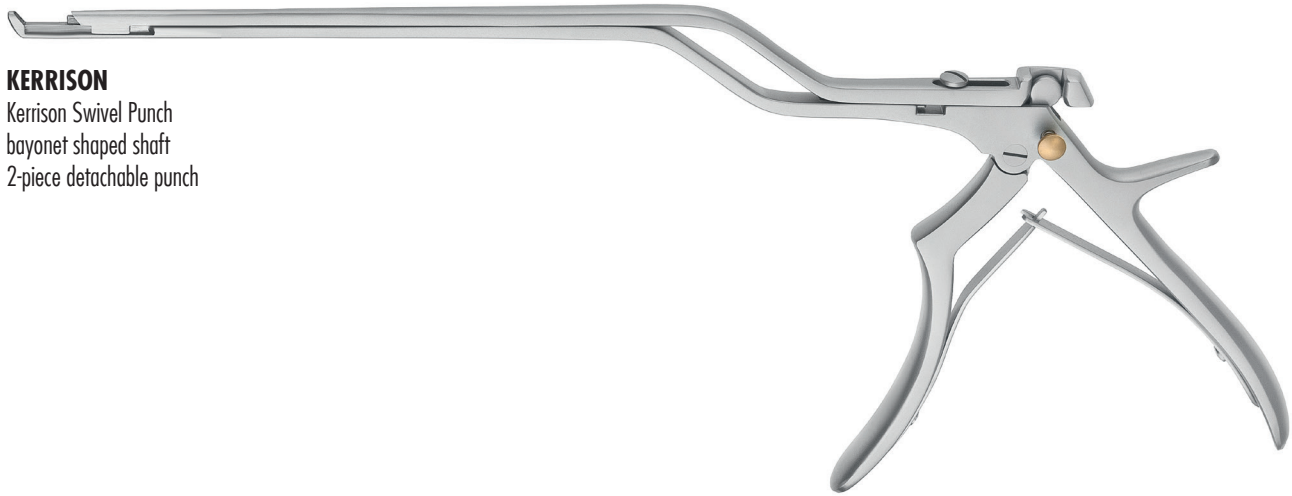

KERRISON

Kerrison Swivel Punch
bayonet shaped shaft
2-piece detachable punch

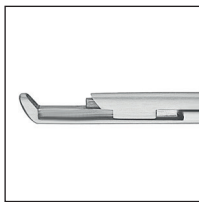

40° upwards cutting



40° upwards cutting
left curved jaw

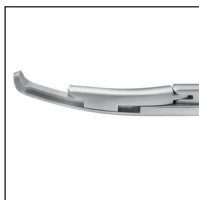

40° upwards cutting
right curved jaw

180mm, 7"	
1mm	250-640-111
2mm	250-640-112
3mm	250-640-113
4mm	250-640-114
5mm	250-640-115
6mm	250-640-116

200mm, 8"	
1mm	250-640-151
2mm	250-640-152
3mm	250-640-153
4mm	250-640-154
5mm	250-640-155
6mm	250-640-156

230mm, 9"	
1mm	250-640-181
2mm	250-640-182
3mm	250-640-183
4mm	250-640-184
5mm	250-640-185
6mm	250-640-186

180mm, 7"	
1mm	250-641-111
2mm	250-651-112
3mm	250-641-113
4mm	250-641-114
5mm	250-641-115
6mm	250-641-116

200mm, 8"	
1mm	250-641-151
2mm	250-641-152
3mm	250-641-153
4mm	250-641-154
5mm	250-641-155
6mm	250-641-156

230mm, 9"	
1mm	250-641-181
2mm	250-641-182
3mm	250-641-183
4mm	250-641-184
5mm	250-641-185
6mm	250-641-186

180mm, 7"	
1mm	250-642-111
2mm	250-642-112
3mm	250-642-113
4mm	250-642-114
5mm	250-642-115
6mm	250-642-116

200mm, 8"	
1mm	250-642-151
2mm	250-642-152
3mm	250-642-153
4mm	250-642-154
5mm	250-642-155
6mm	250-642-156

230mm, 9"	
1mm	250-642-181
2mm	250-642-182
3mm	250-642-183
4mm	250-642-184
5mm	250-642-185
6mm	250-642-186

All instruments are available with CERACUT® coating. Code number + CC (e.g. 250-600-181CC)





KERRISON
Kerrison Swivel Punch
bayonet shaped shaft
black finish, handle with silicone coating



40° upwards cutting

140mm, 5¹/₂" working length

1mm	250-000-001
2mm	250-000-002
3mm	250-000-003
4mm	250-000-004
5mm	250-000-005



90° upwards cutting

140mm, 5¹/₂" working length

1mm	250-000-006
2mm	250-000-007
3mm	250-000-008
4mm	250-000-009
5mm	250-000-010



Disc Rongeurs

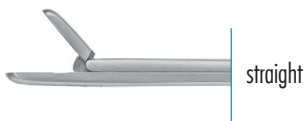

MINI-CUSHING

1.5x10mm bite

180mm, 7" 250-100-181

200mm, 8" 250-100-201

CUSHING

2x10mm bite

130mm, 5^{1/8}" 250-100-132

150mm, 6" 250-100-152

180mm, 7" 250-100-182

200mm, 8" 250-100-202

230mm, 9" 250-100-232



1.5x10mm bite

180mm, 7" 250-110-181

200mm, 8" 250-110-201

2x10mm bite

130mm, 5^{1/8}" 250-110-132

150mm, 6" 250-110-152

180mm, 7" 250-110-182

200mm, 8" 250-110-202

230mm, 9" 250-110-232



1.5x10mm bite

180mm, 7" 250-120-181

200mm, 8" 250-120-201

2x10mm bite

130mm, 5^{1/8}" 250-120-132

150mm, 6" 250-120-152

180mm, 7" 250-120-182

200mm, 8" 250-120-202

230mm, 9" 250-120-232



Laminectomy Rongeurs



LOVE GRUENWALD

straight, 3x10mm bite

130mm, 5 ¹ / ₈ "	250-100-133
150mm, 6"	250-100-153
180mm, 7"	250-100-183
200mm, 8"	250-100-203
230mm, 9"	250-100-233

upwards curved, 3x10mm bite

130mm, 5 ¹ / ₈ "	250-110-133
150mm, 6"	250-110-153
180mm, 7"	250-110-183
200mm, 8"	250-110-203
230mm, 9"	250-110-233

downwards curved, 3x10mm bite

130mm, 5 ¹ / ₈ "	250-120-133
150mm, 6"	250-120-153
180mm, 7"	250-120-183
200mm, 8"	250-120-203
230mm, 9"	250-120-233

SPURLING

straight, 4x10mm bite

130mm, 5 ¹ / ₈ "	250-100-134
150mm, 6"	250-100-154
180mm, 7"	250-100-184
200mm, 8"	250-100-204
230mm, 9"	250-100-234

upwards curved, 5x10mm bite

130mm, 5 ¹ / ₈ "	250-110-134
150mm, 6"	250-110-154
180mm, 7"	250-110-184
200mm, 8"	250-110-204
230mm, 9"	250-110-234

downwards curved, 5x10mm bite

130mm, 5 ¹ / ₈ "	250-120-134
150mm, 6"	250-120-154
180mm, 7"	250-120-184
200mm, 8"	250-120-204
230mm, 9"	250-120-234

CASPAR

straight, 5x10mm bite

130mm, 5 ¹ / ₈ "	250-100-135
150mm, 6"	250-100-155
180mm, 7"	250-100-185
200mm, 8"	250-100-205
230mm, 9"	250-100-235

upwards curved, 5x10mm bite

130mm, 5 ¹ / ₈ "	250-110-135
150mm, 6"	250-110-155
180mm, 7"	250-110-185
200mm, 8"	250-110-205
230mm, 9"	250-110-235

downwards curved, 5x10mm bite

130mm, 5 ¹ / ₈ "	250-120-135
150mm, 6"	250-120-155
180mm, 7"	250-120-185
200mm, 8"	250-120-205
230mm, 9"	250-120-235



CASPAR

Toothed Disc Rongeurs



straight



upwards curved



downwards curved

2x12mm bite

140mm, 5 ¹ / ₂ "	250-130-142
160mm, 6 ¹ / ₄ "	250-130-162
180mm, 7"	250-130-182

2x12mm bite

140mm, 5 ¹ / ₂ "	250-140-142
160mm, 6 ¹ / ₄ "	250-140-162
180mm, 7"	250-140-182

2x12mm bite

140mm, 5 ¹ / ₂ "	250-150-142
160mm, 6 ¹ / ₄ "	250-150-162
180mm, 7"	250-150-182

3x12mm bite

140mm, 5 ¹ / ₂ "	250-130-143
160mm, 6 ¹ / ₄ "	250-130-163
180mm, 7"	250-130-183

3x12mm bite

140mm, 5 ¹ / ₂ "	250-140-143
160mm, 6 ¹ / ₄ "	250-140-163
180mm, 7"	250-140-183

3x12mm bite

140mm, 5 ¹ / ₂ "	250-150-143
160mm, 6 ¹ / ₄ "	250-150-163
180mm, 7"	250-150-183

straight, 4x14mm bite

140mm, 5 ¹ / ₂ "	250-130-144
160mm, 6 ¹ / ₄ "	250-130-164
180mm, 7"	250-130-184

upwards curved, 4x14mm bite

140mm, 5 ¹ / ₂ "	250-140-144
160mm, 6 ¹ / ₄ "	250-140-164
180mm, 7"	250-140-184

downwards curved, 4x14mm bite

140mm, 5 ¹ / ₂ "	250-150-144
160mm, 6 ¹ / ₄ "	250-150-164
180mm, 7"	250-150-184

straight, 5x14mm bite

140mm, 5 ¹ / ₂ "	250-130-145
160mm, 6 ¹ / ₄ "	250-130-165
180mm, 7"	250-130-185

upwards curved, 5x14mm bite

140mm, 5 ¹ / ₂ "	250-140-145
160mm, 6 ¹ / ₄ "	250-140-165
180mm, 7"	250-140-185

downwards curved, 5x14mm bite

140mm, 5 ¹ / ₂ "	250-150-145
160mm, 6 ¹ / ₄ "	250-150-165
180mm, 7"	250-150-185

straight, 6x16mm bite

140mm, 5 ¹ / ₂ "	250-130-146
160mm, 6 ¹ / ₄ "	250-130-166
180mm, 7"	250-130-186

upwards curved, 6x16mm bite

140mm, 5 ¹ / ₂ "	250-140-146
160mm, 6 ¹ / ₄ "	250-140-166
180mm, 7"	250-140-186

downwards curved, 6x16mm bite

140mm, 5 ¹ / ₂ "	250-150-146
160mm, 6 ¹ / ₄ "	250-150-166
180mm, 7"	250-150-186



Swivel Disc Rongeur
2-piece detachable punch, straight

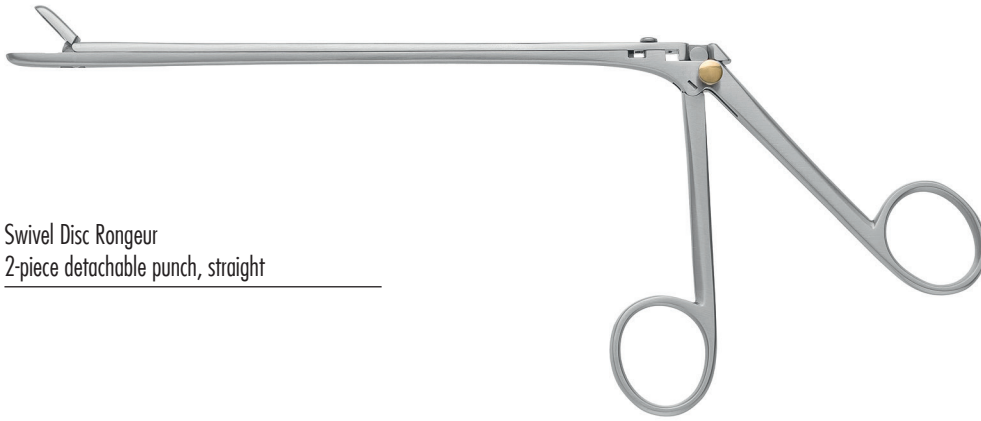

CUSHING
2x10mm

length	straight jaw	30° upwards jaw	30° downwards jaw
150mm, 6"	250-700-152	250-710-152	250-720-152
180mm, 7"	250-700-182	250-710-182	250-720-182
200mm, 8"	250-700-202	250-710-202	250-720-202

LOVE GRUENWALD
3x10mm

length	straight jaw	30° upwards jaw	30° downwards jaw
150mm, 6"	250-700-153	250-710-153	250-720-153
180mm, 7"	250-700-183	250-710-183	250-720-183
200mm, 8"	250-700-203	250-710-203	250-720-202

SPURLING
4x10mm

length	straight jaw	30° upwards jaw	30° downwards jaw
150mm, 6"	250-700-154	250-710-154	250-720-154
180mm, 7"	250-700-184	250-710-184	250-720-184
200mm, 8"	250-700-204	250-710-204	250-720-204

CASPAR
5x10mm

length	straight jaw	30° upwards jaw	30° downwards jaw
150mm, 6"	250-700-155	250-710-155	250-720-155
180mm, 7"	250-700-185	250-710-185	250-720-185
200mm, 8"	250-700-205	250-710-205	250-720-205

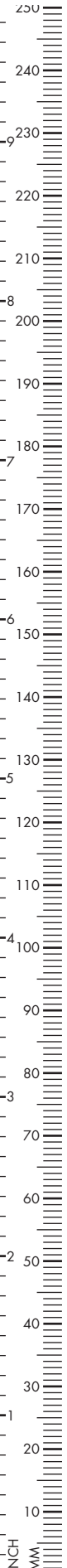

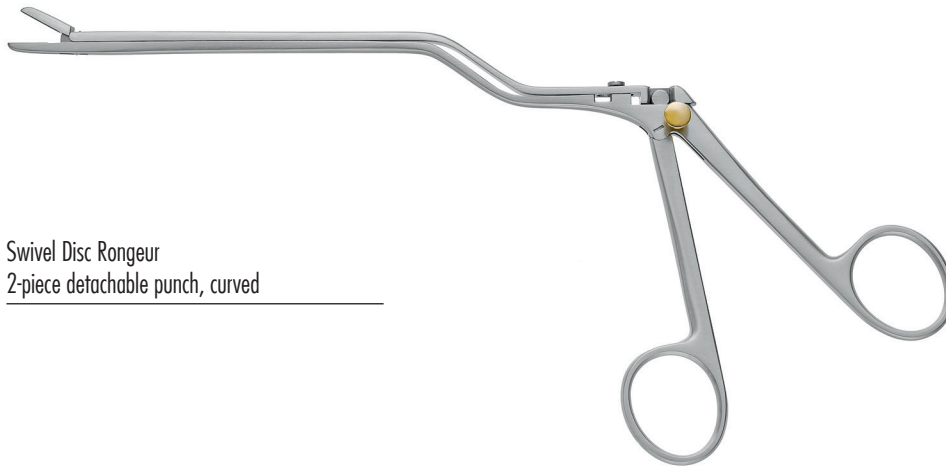

Swivel Disc Rongeur
2-piece detachable punch, curved

CUSHING

2x10mm

length	bayonet right	bayonet left	bayonet up
110mm, 4 ¹ / ₃ "	250-750-112	250-760-112	250-770-112
150mm, 6"	250-750-152	250-760-152	250-770-152
180mm, 7"	250-750-182	250-760-182	250-770-182



LOVE GRUENWALD

3x10mm

length	straight jaw	30° upwards jaw	30° downwards jaw
110mm, 4 ¹ / ₃ "	250-750-113	250-760-113	250-770-113
150mm, 6"	250-750-153	250-760-153	250-770-153
180mm, 7"	250-750-183	250-760-183	250-770-182

SPURLING

4x10mm

length	straight jaw	30° upwards jaw	30° downwards jaw
110mm, 4 ¹ / ₃ "	250-750-114	250-760-114	250-770-114
150mm, 6"	250-750-154	250-760-154	250-770-154
180mm, 7"	250-750-184	250-760-184	250-770-184

CASPAR

5x10mm

length	straight jaw	30° upwards jaw	30° downwards jaw
110mm, 4 ¹ / ₃ "	250-750-115	250-760-115	250-770-115
150mm, 6"	250-750-155	250-760-155	250-770-155
180mm, 7"	250-750-185	250-760-185	250-770-185



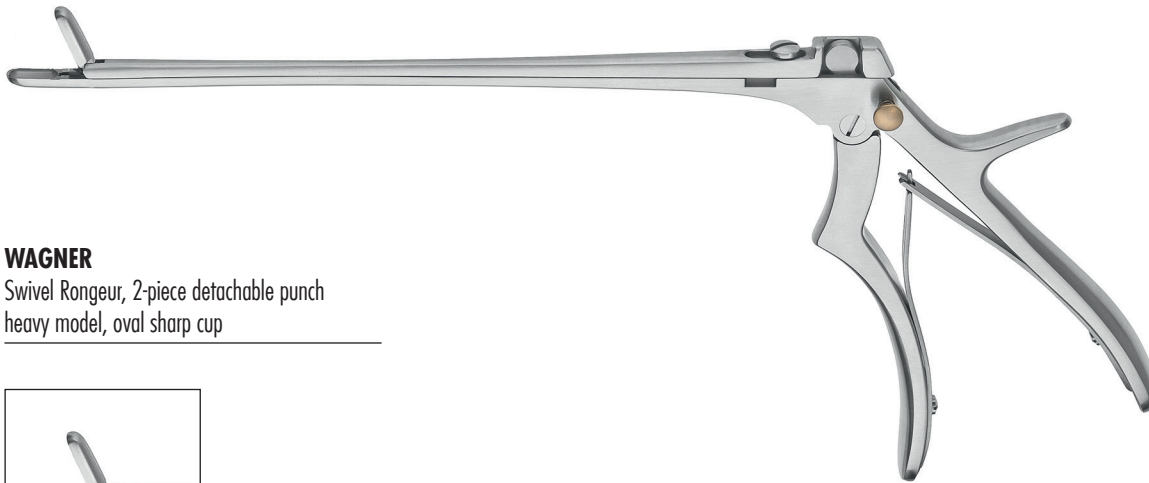

WAGNER

Swivel Rongeur, 2-piece detachable punch heavy model, oval sharp cup



straight
bite

200mm, 8"

300mm, 11⁷/₈"

3mm

250-670-203

250-670-303

4mm

250-670-204

250-670-304

5mm

250-670-205

250-670-305



50° upwards
bite

200mm, 8"

300mm, 11⁷/₈"

4mm

250-671-204

250-671-304

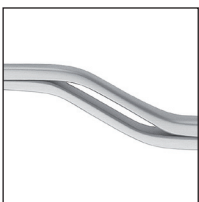

bayonet shape, straight jaw
bite

110mm, 4¹/₃"

150mm, 6"

180mm, 7"

3mm

250-672-113

250-672-153

250-672-183

4mm

250-672-114

250-672-154

250-672-184

5mm

250-672-115

250-672-155

250-672-185

bayonet shape, 50° upwards
bite

110mm, 4¹/₃"

150mm, 6"

180mm, 7"

3mm

250-673-113

250-673-153

250-673-183

4mm

250-673-114

250-673-154

250-673-184

5mm

250-673-115

250-673-155

250-673-185

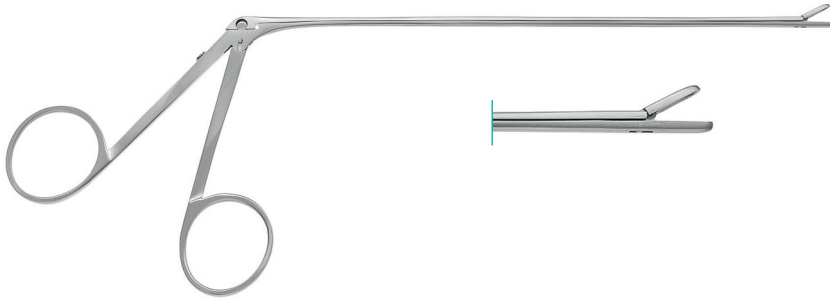

DECKER

Rongeur, fine model, 2x6mm jaw
150mm, 6"

straight	250-066-817
left curved	250-066-824
right curved	250-066-827

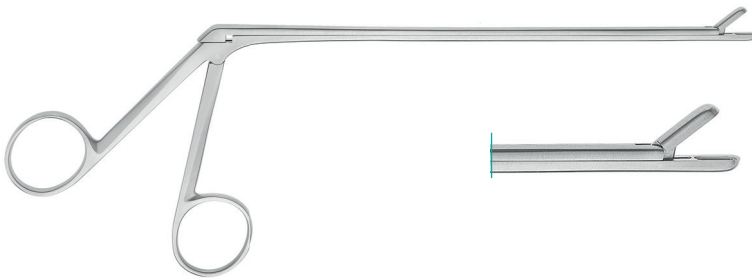

DECKER

Rongeur, 2x6mm jaw, straight
150mm, 6"

250-067-817

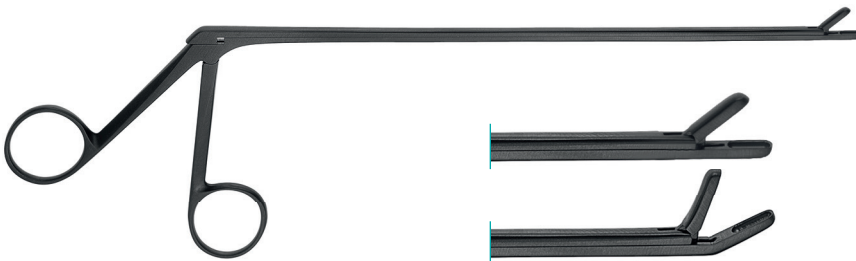

Micro Pituitary, CERA-CUT®
2mm jaw, 170mm, 6²/₃"

straight	250-300-170CC
upcurved	250-301-170CC



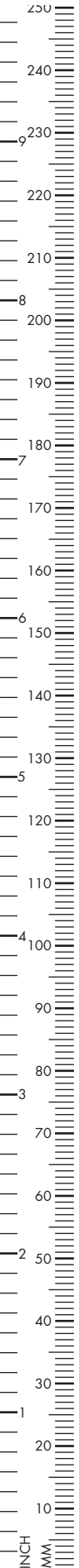

FERRIS SMITH

Disc Rongeur, straight
180mm, 7"

2mm	250-067-802
3mm	250-067-803
4mm	250-067-804
6mm	250-067-806

200mm, 8"

2mm	250-068-802
3mm	250-068-803
4mm	250-068-804
6mm	250-068-806

upwards angled
180mm, 7"

2mm	250-067-782
3mm	250-067-783
4mm	250-067-784
6mm	250-067-786

200mm, 8"

2mm	250-067-765
3mm	250-067-766
4mm	250-067-767
6mm	250-067-768

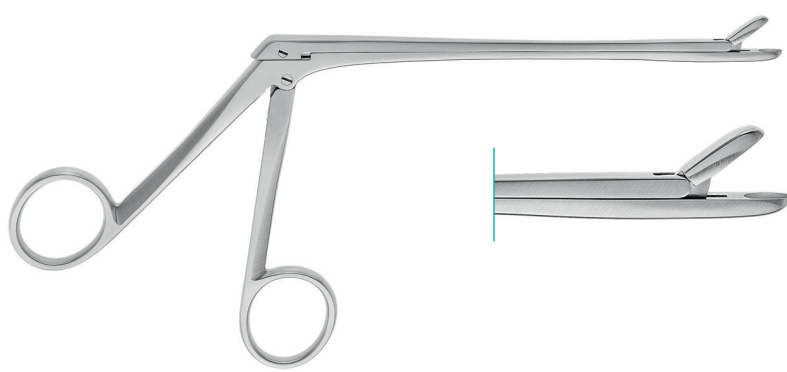

PEAPOD

Rongeur, 140mm, 5¹/₂"
straight

2 x 6mm bite	250-115-140
2.5 x 7mm bite	250-118-140
3 x 10mm bite	250-116-140

upwards angled

2 x 6mm bite	250-114-140
2.5 x 7mm bite	250-119-140
3 x 10mm bite	250-117-140



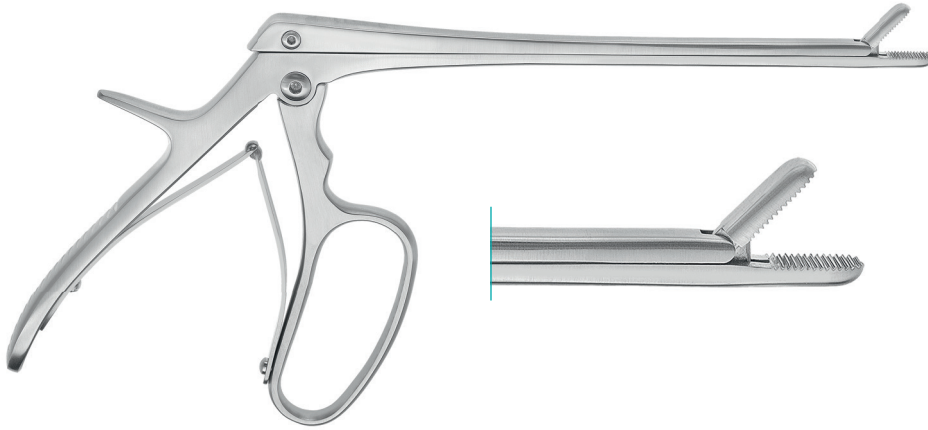

CLOWARD

Rongeur, straight jaw, serrated
180mm, 7"

4mm	250-066-796
-----	-------------

6mm	250-066-797
-----	-------------

200mm, 8"	
-----------	--

4mm	250-066-786
-----	-------------

6mm	250-066-787
-----	-------------

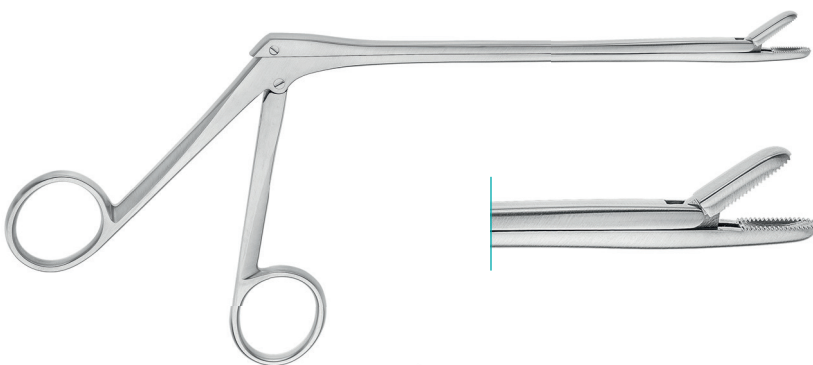

SCHLESINGER

Rongeur, straight jaw, fine serrated
150mm, 6"

2mm	259-195-002
-----	-------------

3mm	259-195-003
-----	-------------

4mm	259-195-004
-----	-------------

180mm, 7"	
-----------	--

2mm	259-196-002
-----	-------------

3mm	259-196-003
-----	-------------

4mm	259-196-004
-----	-------------



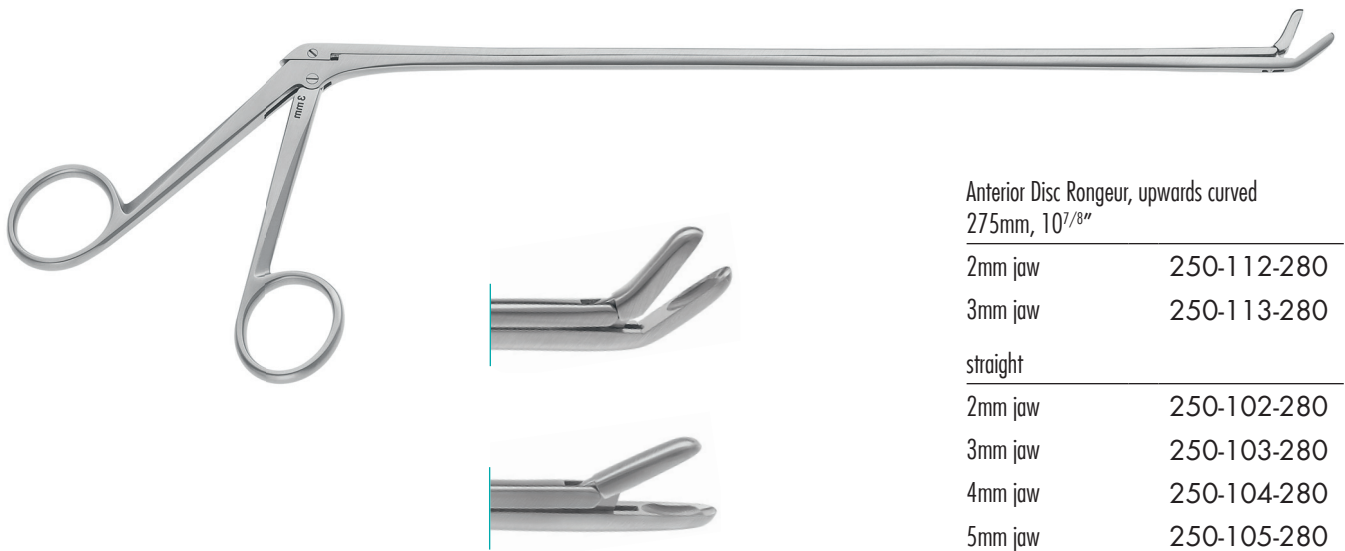

Anterior Disc Rongeur, upwards curved
275mm, 10^{7/8}"

2mm jaw	250-112-280
3mm jaw	250-113-280
straight	
2mm jaw	250-102-280
3mm jaw	250-103-280
4mm jaw	250-104-280
5mm jaw	250-105-280



VILBISS

Cranial Rongeur Forceps
with replacement blade

210mm, 8^{1/4}" 250-066-798

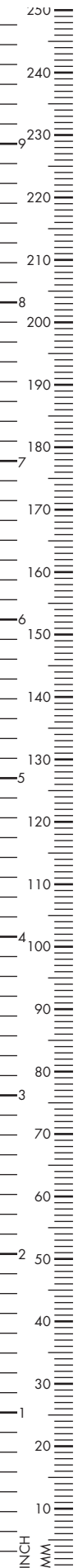

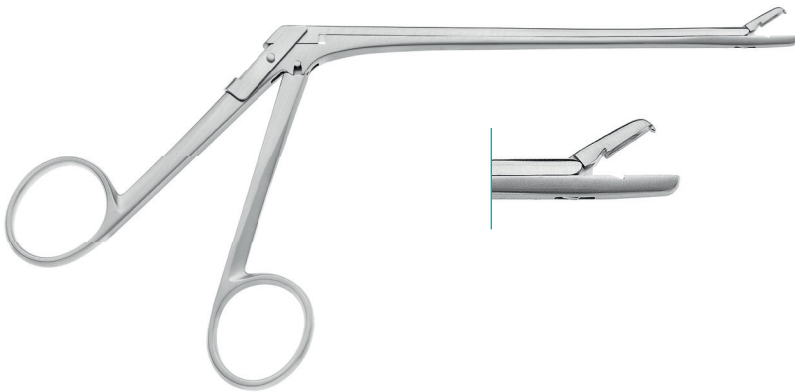

WILLIAMS

Dissectomy Rongeur, 2.3mm wide cup,
1.0mm single teeth

140mm, 5 ¹ / ₂ "	250-068-140
230mm, 9"	250-068-230

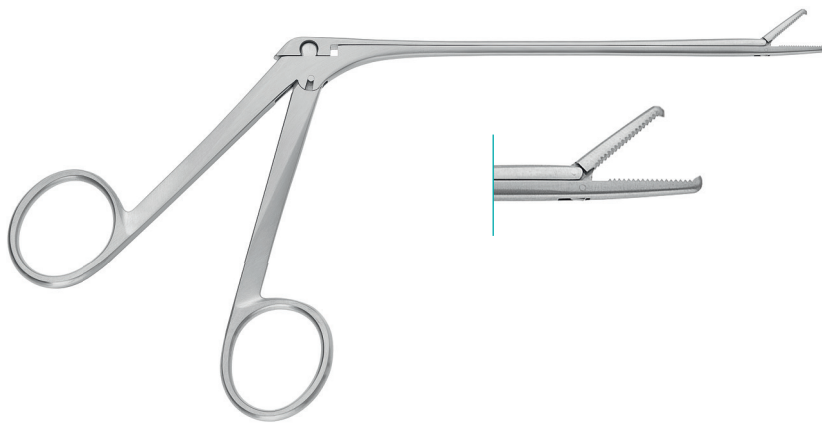

NOYES

Alligator Forceps, 1x2 teeth with serrated jaw

140mm, 5 ¹ / ₂ "	250-526-140
--	-------------

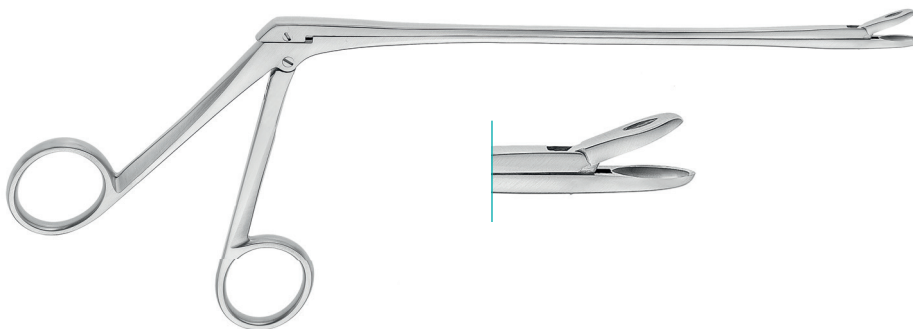

WEIL BLAKESLEY

Rongeur, fenestrated jaw, fine serrated
180mm, 7", straight

3.0mm	252-030-180
3.5mm	252-035-180
4.0mm	252-040-180
upwards angled	
3.0mm	252-030-181
3.5mm	252-035-181
4.0mm	252-040-181



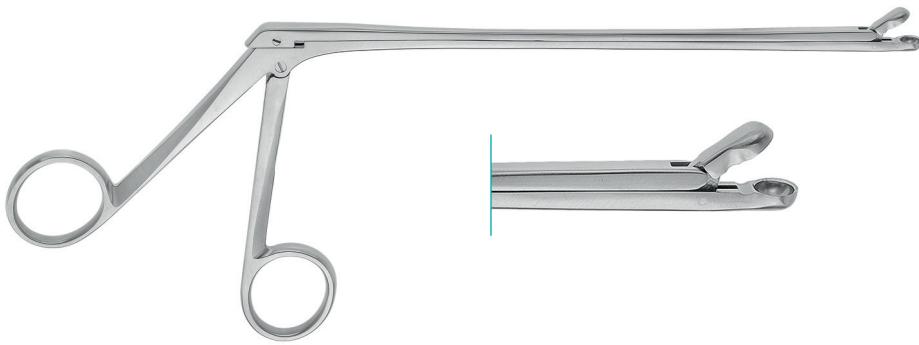

OLDBERG

Rongeur, Ø7mm

180mm, 7"

250-066-605

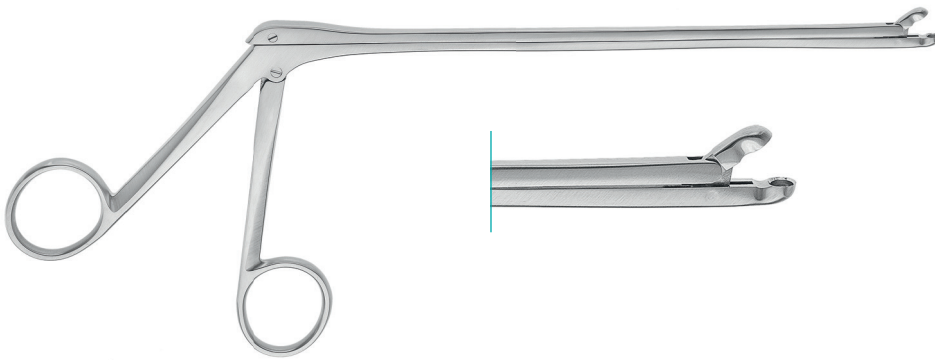

YASARGIL

Rongeur, 190mm, 7¹/₂"

Ø2.2mm

250-066-599

Ø3.5mm

250-066-600

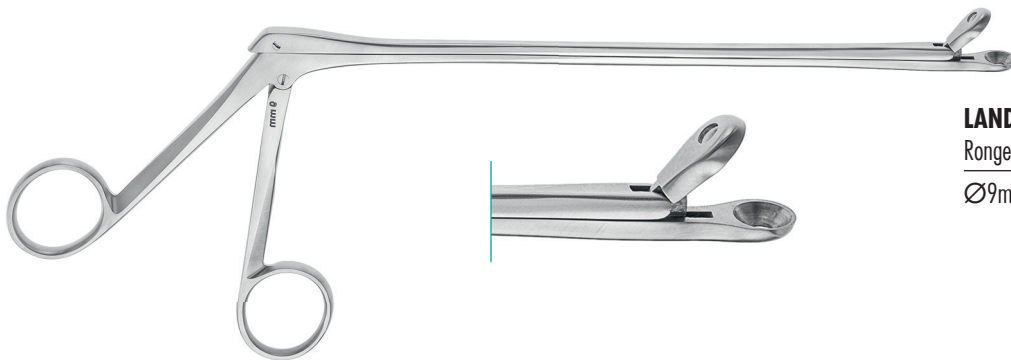

LANDOLT

Rongeur, 200mm, 8"

Ø9mm

250-066-345





Micro Dissectomy Rongeur,
black coated, 180mm, 7"

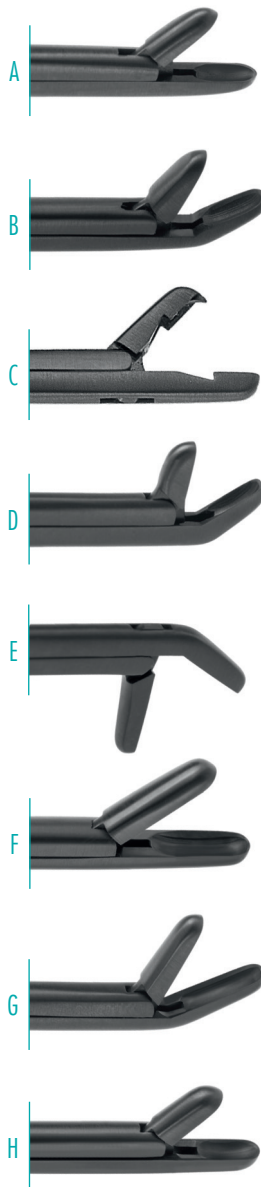

A	straight, 2x6mm	250-000-016
B	30° bent up, 2x6mm	250-000-017
C	Grasper, 2mm	250-000-018
D	40° upwards curved, 2x6mm	250-000-019
E	downwards curved, 2x6mm	250-000-020
F	straight, 4mm	250-000-021
G	upwards angled, 4mm	250-000-022
H	short straight, Kerrison handle 4mm	250-000-023