



ИНСТРУМЕНТЫ ДЛЯ
РИНОЛОГИИ

RHINOLOGY

RZ Medizintechnik®
PROGRESS IN SURGERY

ООО "Эндомедпроект" является уполномоченным представителем компании RZ-Medizintechnik GmbH в России.

Компания RZ-Medizintechnik GmbH является производителем оборудования и инструментов для всех разделов жёсткой эндоскопии (лапароскопии, эндоурологии, эндогинекологии, артроскопии, ЛОР, пластической хирургии и др.). Продукция RZ-Medizintechnik является образцом немецкого качества и соответствует европейским стандартам, благодаря чему пользуется популярностью во всем мире.

Будем рады взаимовыгодному сотрудничеству!

Наши контакты:

127486, Москва, Коровинское ш., дом 1, корп.2, нежилое помещение XIII (13).

E-mail: office@emp77.ru

<https://www.emp77.ru/>

Телефон: 8 (495) 649-6347

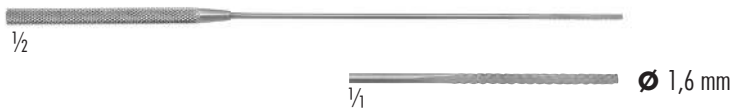

160-426-160 Ø 1,6 mm
Nasenvatteträger, Arbeitsende dreikant gerieft, 160 mm
Nasal applicator, triangular serrated end, 6 ¼ inch

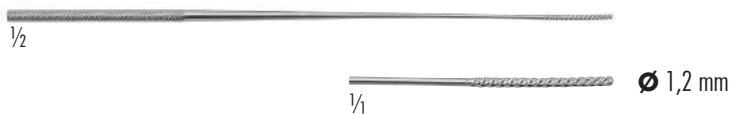

160-420-165 Ø 1,2 mm
FARREL
Nasenvatteträger, Arbeitsende spiralförmig gerieft, 160 mm
Nasal applicator, rough spiral end, 6 ¼ inch

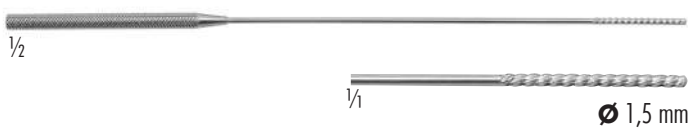

160-412-180 Ø 1,5 mm
Nasenvatteträger, Arbeitsende spiralförmig gerieft, 180 mm
Nasal applicator, rough spiral end, 7 inch

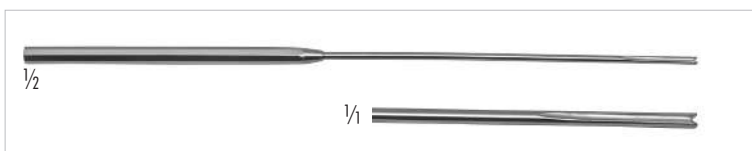

420-150-180
SIEBENMANN
Nasentopfer, 180 mm
Nasal plugger, 7 inch



420-413-230

LANGE

Choanenhook, 230 mm
Choana hook, 9 1/2 inch



420-201-260

KRAUSE

Nasenpolypenschnürer, kniegebogen, 250 mm
Nasal polypus snare, knee bent, 10 inch

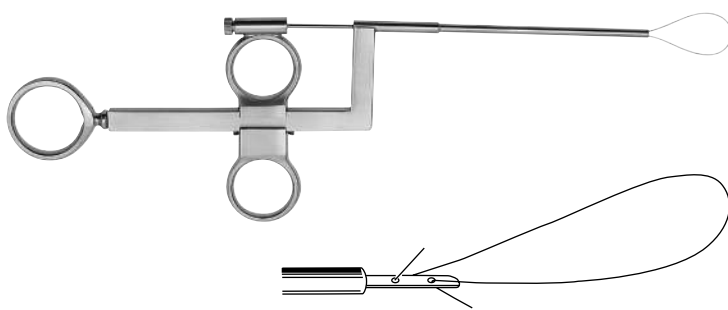

410-270-250

WILDE

Nasenpolypenschnürer, bajonettförmig gebogen, 250 mm
Nasal polypus snare, bayonet shaped, 10 inch



420-210-003 Ø 0,3 mm

Schlingen für Nasenpolypenschnürer,
Bestelleinheit: PH=Packung á 100 Stück
Wire loops for nasal snares,
sales unit: PH=Package of 100 pieces



420-210-013 Ø 0,3 mm

Schnürerdraht in Rollen á 10 m
Snare wire in coils of 10 metres

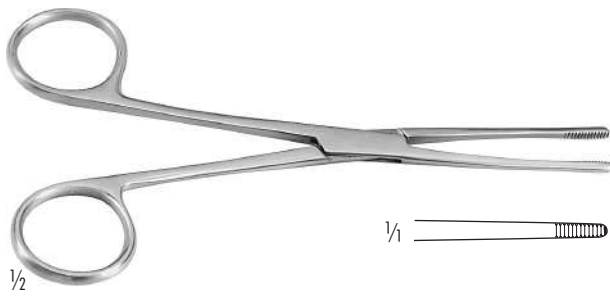

150-080-160 155 mm/6 inch
 150-080-180 180 mm/7 inch
LISTER
 Tamponzange
 Sinus forceps

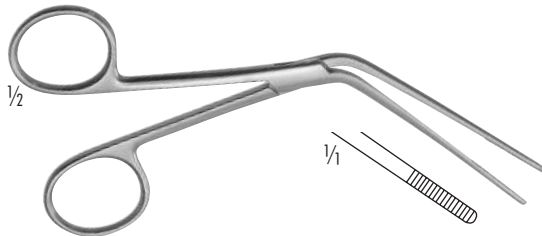

410-232-140
TILLEY
 Nasentamponzange, 130 mm
 Nasal dressing forceps, 5 1/8 inch

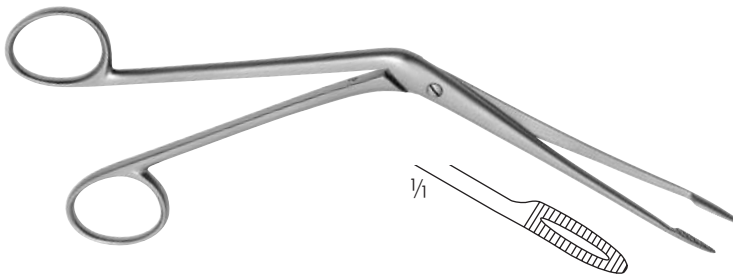

420-211-200
HARTMANN
 Nasentamponzange, 215 mm
 Nasal dressing forceps, 8 1/4 inch

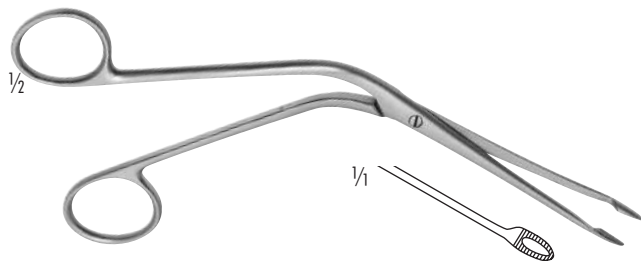

420-211-160
HARTMANN
 Nasentamponzange, 175 mm
 Nasal dressing forceps, 7 inch

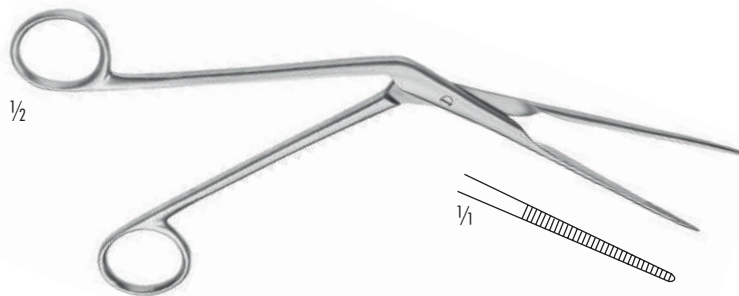

420-411-200
WEST
 Nasentamponzange, 200 mm
 Nasal dressing forceps, 8 inch

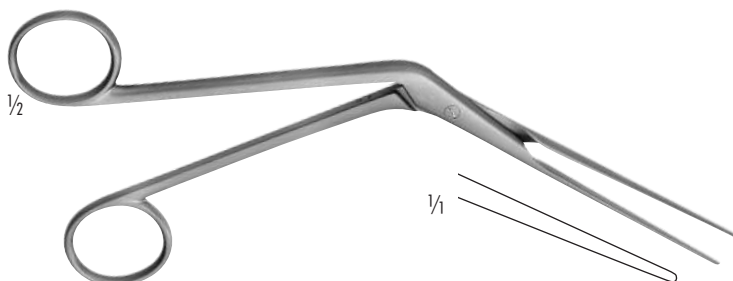

420-210-200
LUBET-BARBON
 Nasentamponzange, 200 mm
 Nasal dressing forceps, 8 inch



- 120-284-180 gerade/straight
gezahntes oberes Blatt/
serrated upper blade
- 120-287-180 rechts gebogen/right curved
gezahnt/serrated
- 120-285-180 links gebogen/left curved
gezahnt/serrated
- 120-585-180 **TC**, unteres Blatt gezahnt, gerade
TC, lower blade serrated, straight

HEYMANN
Nasenschere, 190 mm,
Nasal scissors, 7 1/2 inch

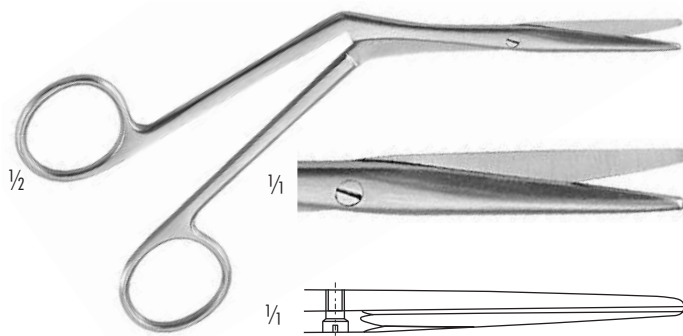

120-283-180
HEYMANN-KNIGHT
Nasenschere, 180 mm
Nasal scissors, 7 inch

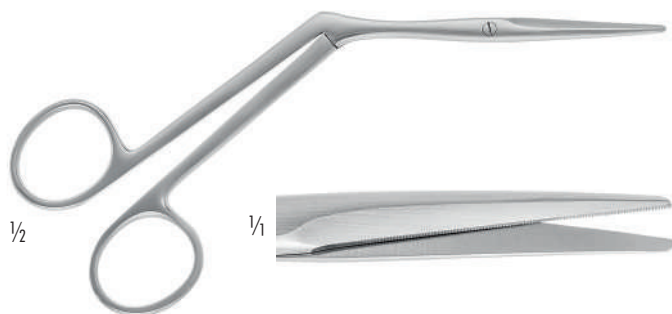

120-285-175
KIRSTEIN
Nasenschere, gezahnt, 180 mm
Nasal scissors, serrated, 7 inch

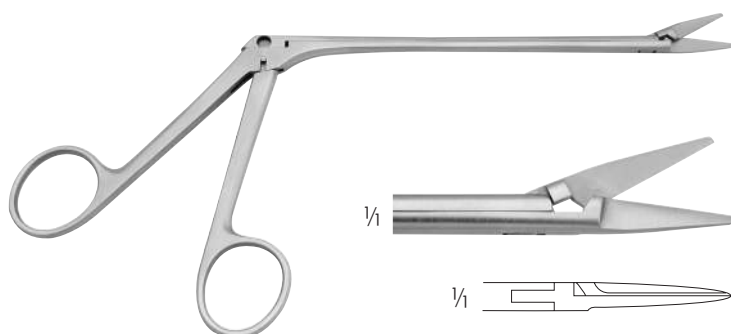

120-208-230
OLIVECRONA
Nasenschere, 230 mm
Nasal scissors, 9 inch

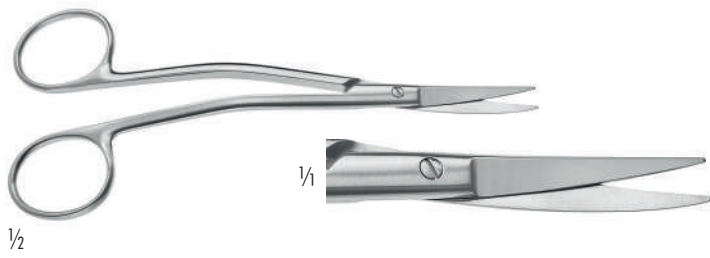

120-306-140

JOSEPH

Nasenschere, doppelt gebogen, stumpf, 140 mm
Nasal scissors, double curved, blunt, 5 1/2 inch

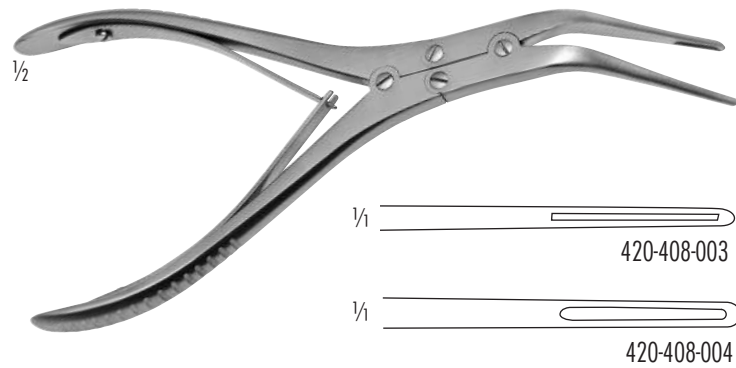

420-408-003 3 mm

420-408-004 4 mm

KRESSNER

Muschelquetschzangen, 220 mm
Crushing forceps, 8 3/4 inch

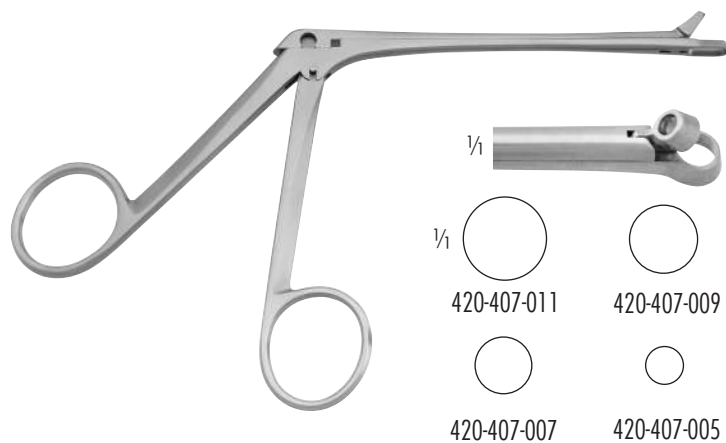

420-407-005 5mm

420-407-007 7mm

420-407-009 9mm

420-407-011 11mm

HARTMANN

Conchotom, durchschneidend, 120 mm
Nasal cutting forceps, through cutting, 4 1/2 inch

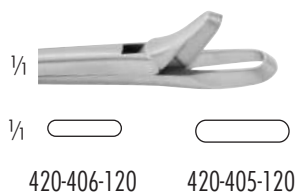

420-406-120 420-405-120

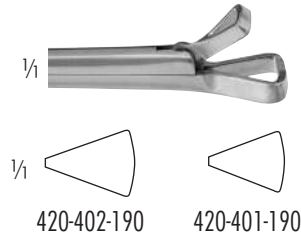

420-402-190 420-401-190

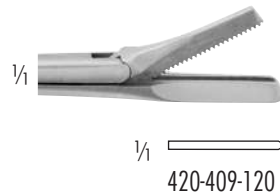

420-409-120

420-405-120 3,5 x 11mm

420-406-120 2,0 x 9,5mm

GRUENWALD-HENKE

Conchotom, durchschneidend
Nasal cutting forceps, through cutting

420-401-190 Fig. 1

420-402-190 Fig. 2

SCHMEDEN

Conchotom, durchschneidend
Nasal cutting forceps, through cutting

420-409-120

STRUYCKEN

Conchotom, durchschneidend
Nasal cutting forceps, through cutting

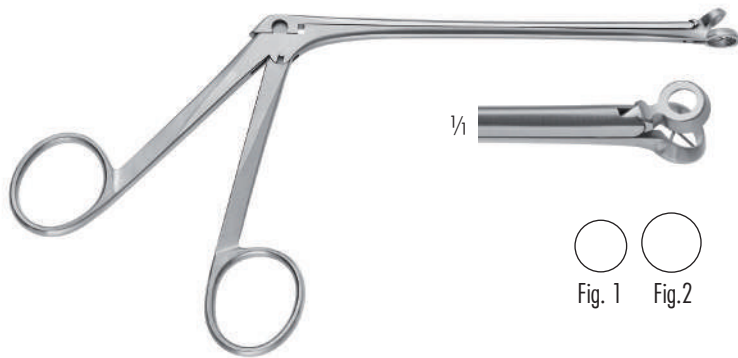

420-401-001 7 mm, Fig.1
 420-401-002 8 mm, Fig.2

MELZER

Adenoidzange, durchschneidend, rund, mit Gitter, 140 mm
 Adenoid Forceps, through cutting, round, with basket, 140 mm



420-421-001 3 mm Schnitt/3 mm bite Fig.1
 420-421-002 3,5 mm Schnitt/3.5 mm bite Fig.2
 420-421-003 4 mm Schnitt/4 mm bite Fig.3

GRUENWALD

Nasenzange, durchschneidend, ovaler Schnitt, Arbeitslänge: 115 mm
 Nasal Forceps, through cutting, oval bite, Working length: 4 1/2 inch

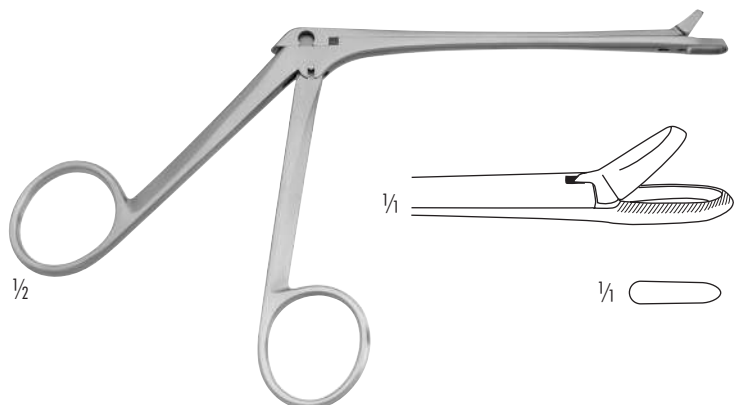

420-410-120

MYLES

Conchotom, durchschneidend, 120 mm
 Nasal cutting forceps, through cutting, 4 3/4 inch

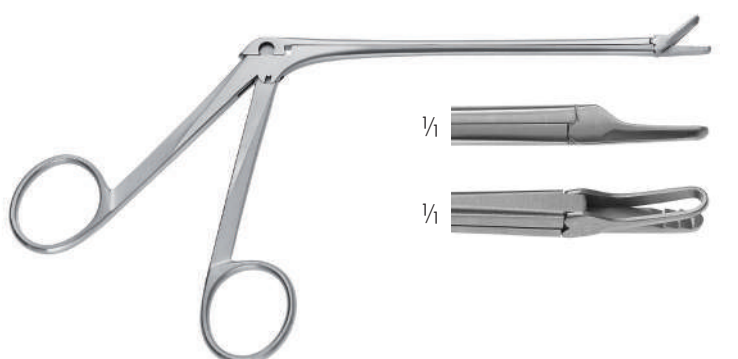

420-410-140

MYLES

Conchotom, durchschneidend, 2,5 x 11,5 mm flaches, gezahntes Maul, Arbeitslänge: 140 mm
 Nasal Punch, through cutting, 2.5 x 11.5 mm flat, serrated jaw, Working length: 5 1/2 inch

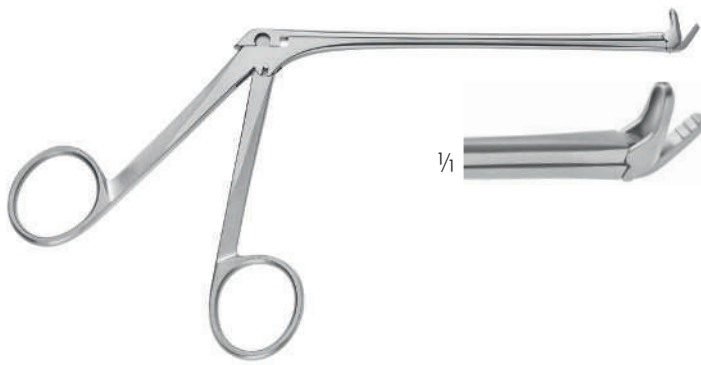

420-413-140

MYLES

Conchotom, durchschneidend, gezahnt, 30° aufgebogen, Arbeitslänge: 140 mm

Nasal Punch, through cutting, serrated, 30° upcurved shaft, Working length: 5 1/2 inch

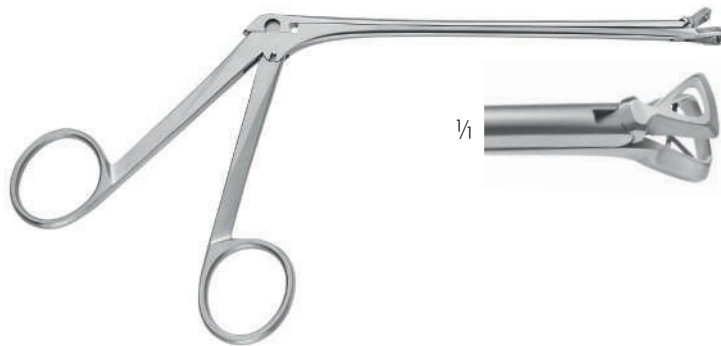

420-401-100 6 mm, Fig.0

420-401-101 7 mm, Fig.1

420-401-102 8 mm, Fig.2

420-401-103 10 mm, Fig.3

MELZER

Adenoidzange, durchschneidend, dreieckig, mit Gitter, Arbeitslänge: 140 mm

Adenoid Forceps, through cutting, triangular, with basket, Working length: 5 1/2 inch

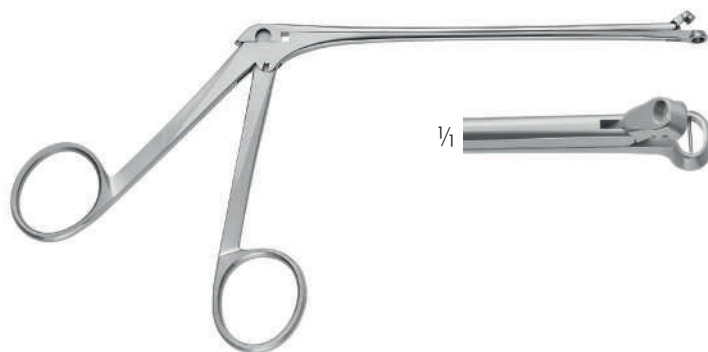

420-401-201 5,2 x 3,2mm Fig.1

MELZER

Adenoidzange, durchschneidend, oval, Arbeitslänge: 140 mm

Adenoid Forceps, through cutting, oval, Working length: 5 1/2 inch



420-414-120 gerade/straight

420-415-120 links gebogen/left curved

420-416-120 rechts gebogen/right curved

Nasenschere, 120 mm

Nasal scissors, 4 3/4 inch

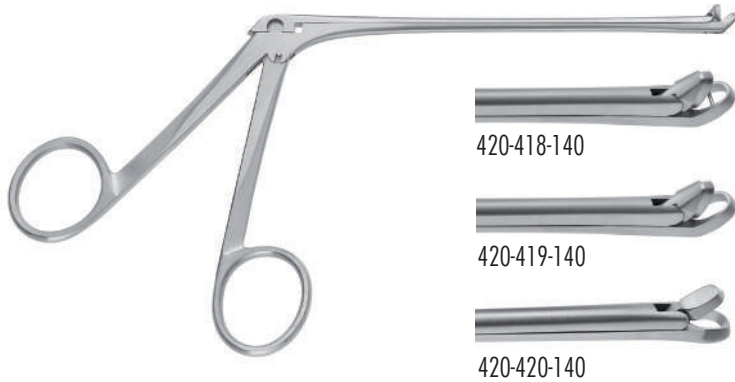

- 420-418-140 Mit Gitter, aufgebogen/
with basket, curved up
- 420-419-140 Ohne Gitter, aufgebogen/
without basket, curved up
- 420-420-140 Ohne Gitter, gerade/
without basket, straight

WATSON-WILLIAMS

Nasenzange, durchschneidend, 3 mm Schnitt,
Arbeitslänge: 140 mm
Nasal Forceps, through cutting, 3 mm bite,
Working length: 5 ½ inch

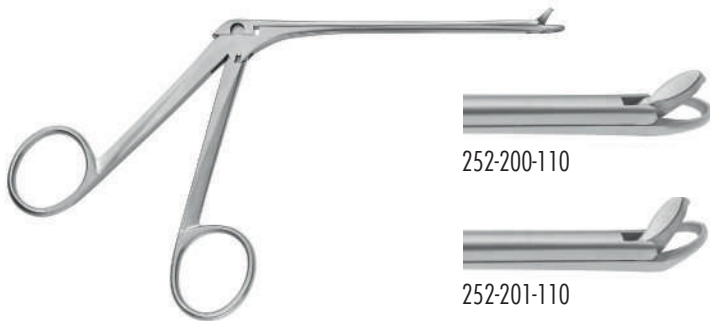

- 252-200-110 2 mm Schnitt, gerade/bite, straight
- 252-200-111 2,5 mm Schnitt, gerade/bite, straight
- 252-200-112 3 mm Schnitt, gerade/bite, straight
- 252-201-110 2 mm Schnitt, aufgebogen/bite, upcurved
- 252-201-111 2,5 mm Schnitt, aufgebogen/bite, upcurved
- 252-201-112 3 mm Schnitt, aufgebogen/bite, upcurved

BLAKESLEY

Nasenzange, durchschneidend, 115 mm
Nasal Forceps, through cutting, 4 ½ inch

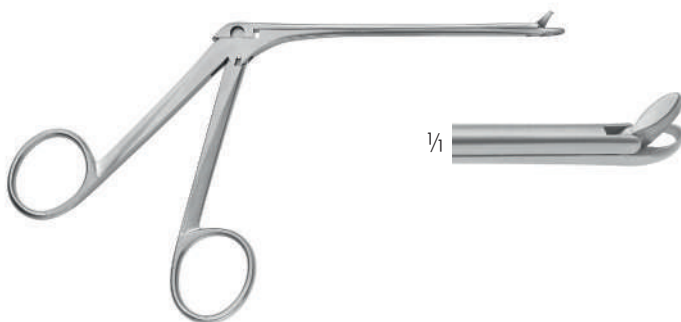

- 252-202-111 Fig.1 links gebogen/left curved jaw
- 252-203-111 Fig.2 rechts gebogen/right curved jaw

BLAKESLEY

Nasenzange, durchschneidend, 2,5mm Schnitt, 115mm
Nasal Forceps, though cutting, 2.5mm cut, 4 ½ inch



- 252-477-141 rückwärts öffnend/backward cutting
- 252-477-142 links öffnend/left side cutting
- 252-477-143 rechts öffnend/right side cutting

NICOLAI

Stirnhöhlenzange 2mm Schnitt, 65° aufgebogen
Antrum Forceps, 2mm bite, 65° angled upwards

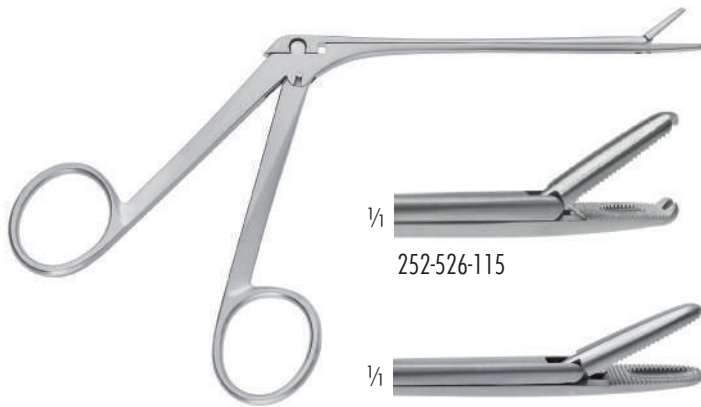

1/1
252-526-115



1/1
252-527-115



1/1
252-528-115



1/1
252-529-115



1/1
252-530-115

252-526-115 **NOYES** gefenstert/fenestrated
1x2 Zähne/teeth

252-527-115 **NOYES** gefenstert/fenestrated

252-528-115 **MORGENSTEIN**

252-529-115 **BLAKESLEY**

252-530-115 **FERRIS-SMITH**

Nasenzange mit Querzähnen, Arbeitslänge: 115 mm

Nasal Forceps with serrated jaws, Working length: 4 1/2 inch

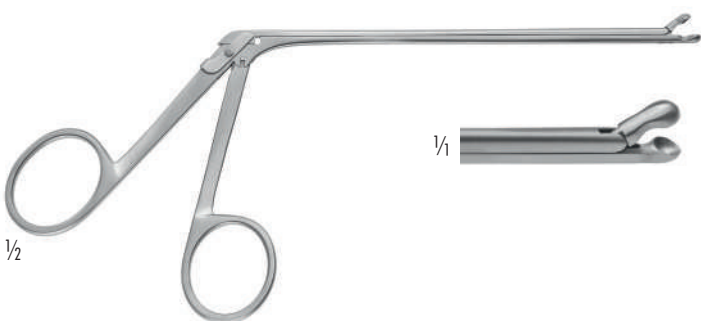

1/2

1/1

420-223-170

HILDYARD

Löffelzängchen, 3,5 mm Löffel, 120 mm Schaftlänge,
Arbeitslänge: 120 mm

Post-Nasal Biopsy Forceps, 3.5 mm biopsy cup, shaft
Working length: 4 3/4 inch

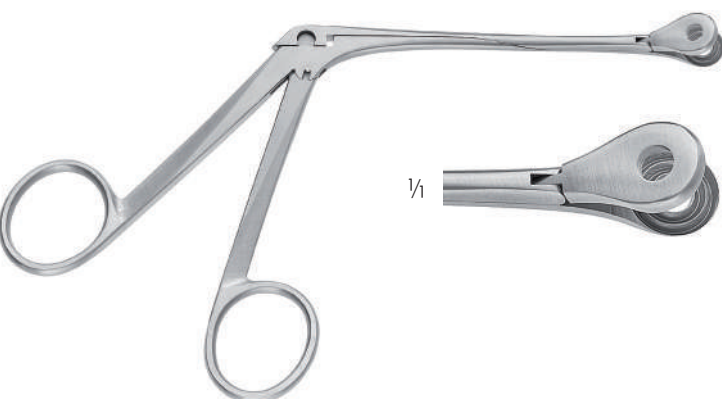

1/1

252-539-115

LEWIS

Nasenzange seitlich links öffnend, Arbeitslänge: 115mm

Nasal Forceps, round grooved jaws, opening to left side,
Working length: 4 1/2 inch

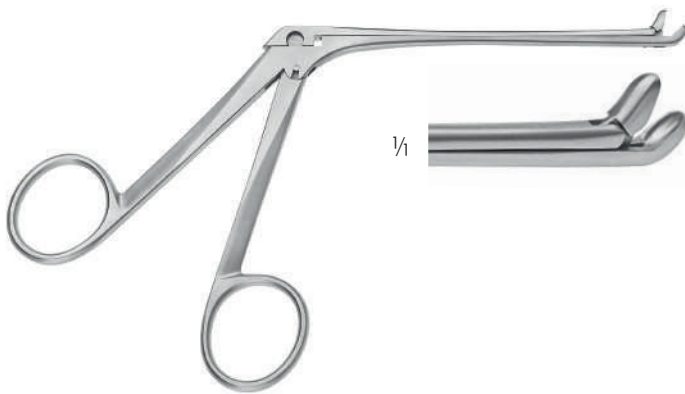

252-425-115

BEAD

Bead Nasenzange mit Löffel, aufgebogen, kleines Modell , Arbeitslänge: 115mm

Nasal Forceps with cup jaws, upturned, small model, Working length: 4 1/2 inch

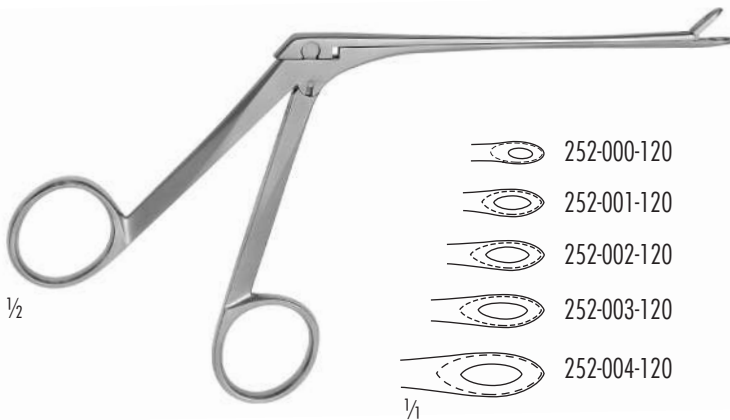

- 252-000-120 Fig.0 3,0 mm
- 252-001-120 Fig.1 3,6 mm
- 252-002-120 Fig.2 4,2 mm
- 252-003-120 Fig.3 4,8 mm
- 252-004-120 Fig.4 5,6 mm

WEIL-BLAKESLEY

Siebbeinzangen, gerade, ovaler Löffel, gefenstertes Maul, 120 mm
Ethmoidal forceps, straight, oval, cup-shaped fenestrated jaws, 4 3/4 inch

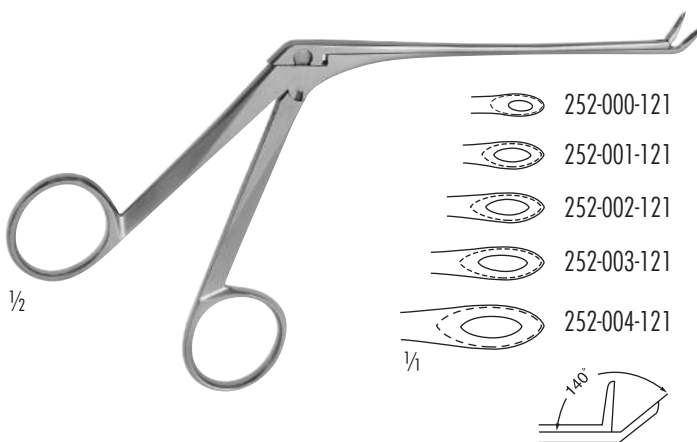

- 252-000-121 Fig.0 3,0 mm
- 252-001-121 Fig.1 3,6 mm
- 252-002-121 Fig.2 4,2 mm
- 252-003-121 Fig.3 4,8 mm
- 252-004-121 Fig.4 5,6 mm

WEIL-BLAKESLEY

Siebbeinzangen, aufgebogen, ovaler Löffel, gefenstertes Maul, 110 mm
Ethmoidal forceps, upwards curved, oval cup, fenestrated jaws, 4 1/2 inch

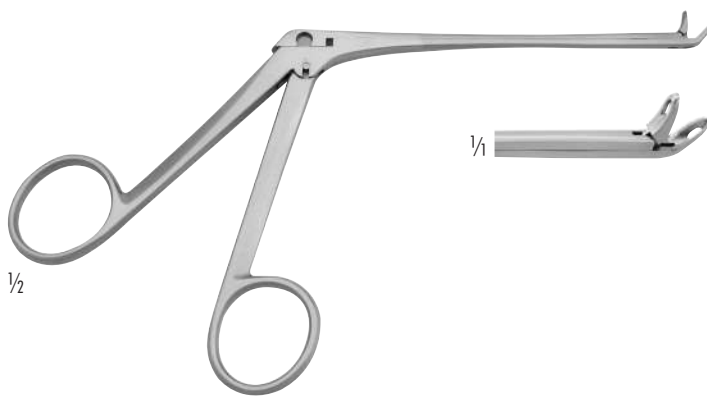

252-000-111

STRUEMPEL-VOSS

Siebbeinzange 45° aufgebogen, besonders fein, 2,5mm
110 mm Schaft

Ethmoidal forceps, 45° upwards curved, oval, very delicate, 2.5mm
110 mm shaft

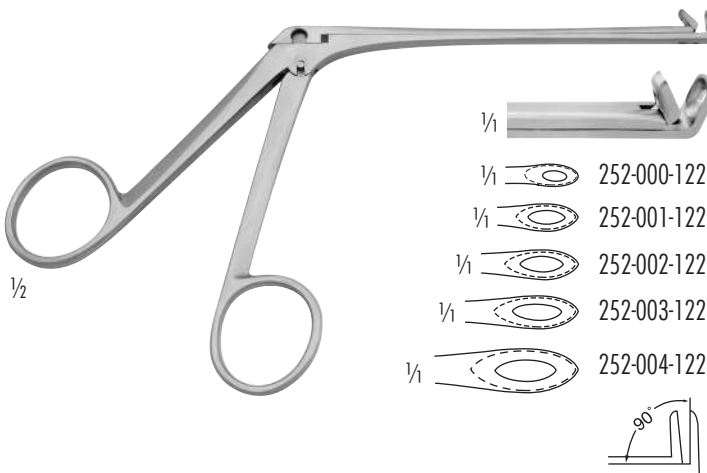

- 252-000-122 Fig.0 3,0 mm
- 252-001-122 Fig.1 3,6 mm
- 252-002-122 Fig.2 4,2 mm
- 252-003-122 Fig.3 4,8 mm
- 252-004-122 Fig.4 5,6 mm

WEIL-BLAKESLEY

Siebbeinzange, 90° aufgewinkelt, 110 mm
Ethmoidal forceps, 90° angled up, 4 1/2 inch



- 0°
- 252-035-150 Größe/Size 1: 3,5mm
- 252-040-150 Größe/Size 2: 4,0mm
- 252-050-150 Größe/Size 3: 5,0mm

- 45°
- 252-035-151 Größe/Size 1: 3,5mm
- 252-040-151 Größe/Size 2: 4,0mm

- 90°
- 252-035-152 Größe/Size 1: 3,5mm
- 252-040-152 Größe/Size 2: 4,0mm

BLAKESLEY

Nasenzange, Arbeitslänge: 150mm Arbeitslänge:
Nasal Forceps, working length: 6 inch



- 252-022-045 4,5 mm
- 252-022-055 5,5 mm
- 252-022-065 6,5 mm

TILLEY HENCKEL

Siebbeinzange, gerade, Schaft graduiert, 115 mm
Ethmoidal forceps, straight, shaft graduated, 4 1/2 inch



- 252-410-130 2 mm, gerade/straight
- 252-410-131 3 mm, gerade/straight
- 252-413-131 3 mm, aufgebogen/curved up

TAKAHASHI

Siebbeinzange, oval, Löffelmaul, 120 mm
Ethmoidal forceps, oval, cup-shaped, 4 3/4 inch



- 252-534-100
Siebbeinzange, gerade, 140 mm
Ethmoidal forceps, straight, 5 1/2 inch

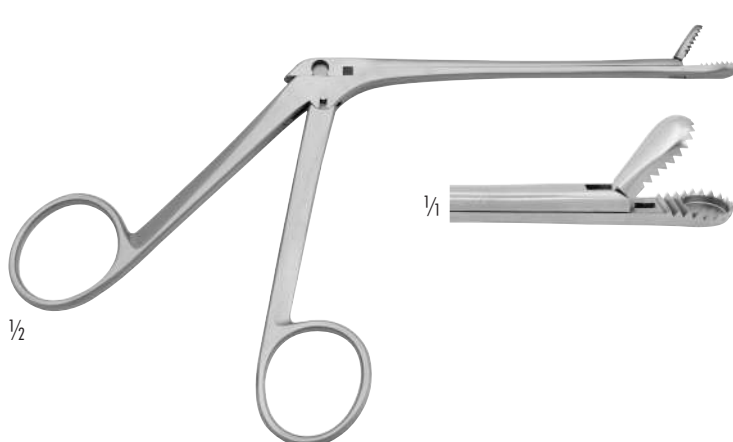

- 252-530-120
WATSON-WILLIAMS
Schleimhaut Faßzange, gezahnt, gerade, 120 mm
Ethmoidal mucosa forceps, serrated jaws, straight, 4 3/4 inch

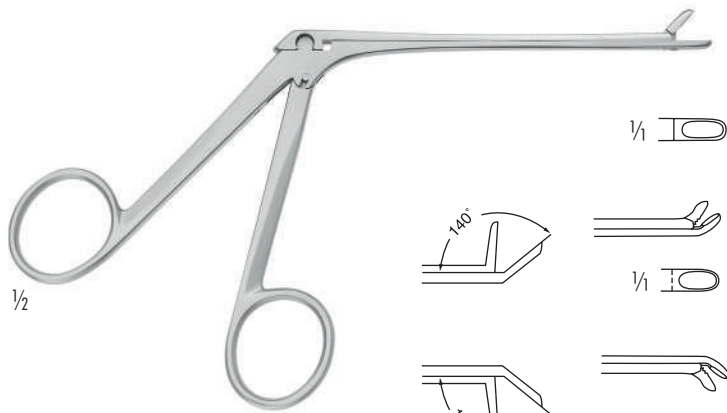

- 252-536-115 gerade/straight
- 252-537-115 aufgebogen/curved up
- 252-538-115 abgebogen/curved down

ST BARTS

Rongeur, 3 mm, 110 mm
 Rongeur, 3 mm, 4 1/3 inch

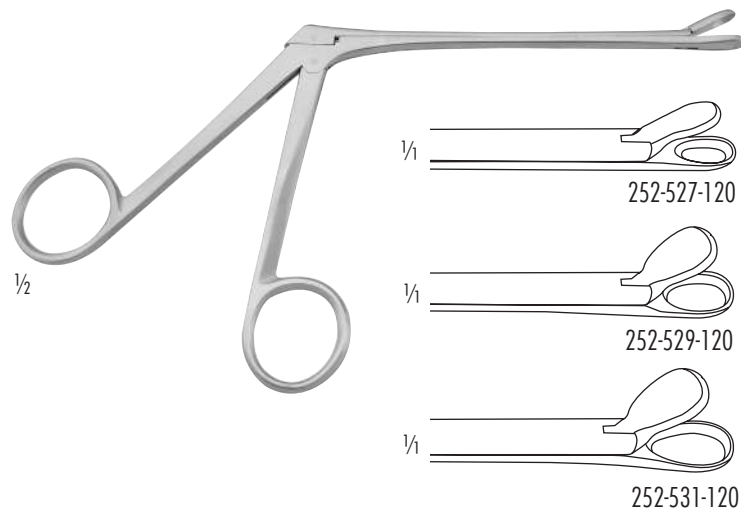

- 252-527-120 Fig.0
- 252-529-120 Fig.1
- 252-531-120 Fig.2

WATSON-WILLIAMS

Siebbeinzange, 115 mm
 Ethmoidal forceps, 4 1/2 inch

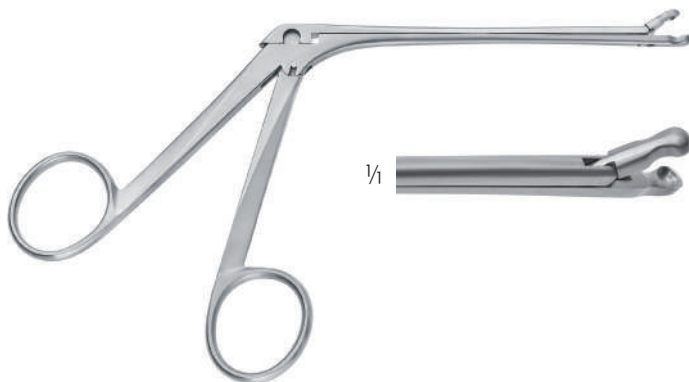

252-426-100 Ø 3.5 mm
 Nasenzange mit rundem Löffel, 115 mm
 Sinus Cup Forceps, 4 1/2 inch

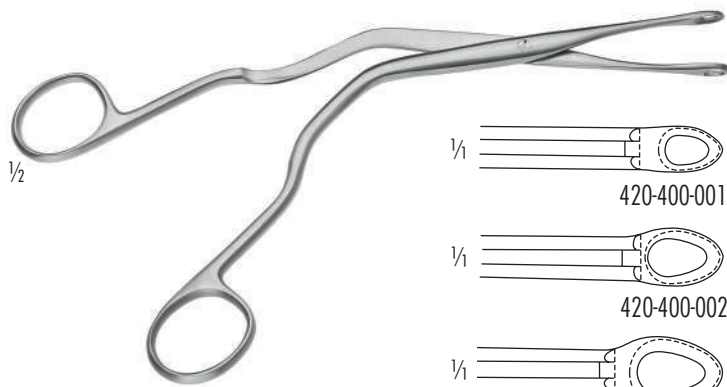

- 420-400-001 6,0 mm
- 420-400-002 7,5 mm
- 420-400-003 9,0 mm

LUC

Septumzange, gefenstert, 190 mm
Septum forceps with fenestrated jaws, 7 1/2 inch

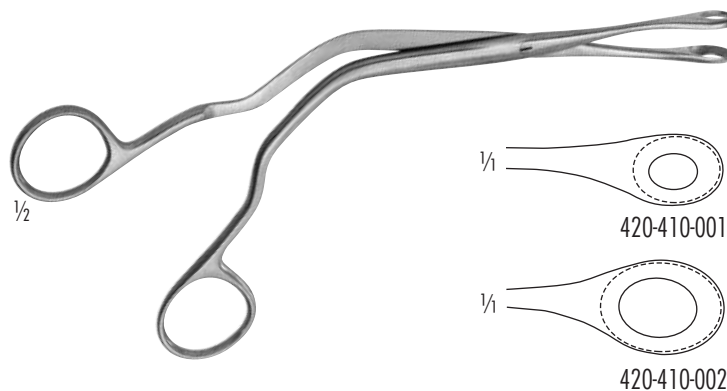

- 420-410-001 Fig. 1
- 420-410-002 Fig. 2

LUC

Septumzange, gefenstert, 200 mm
Septum forceps with fenestrated jaws, 8 inch

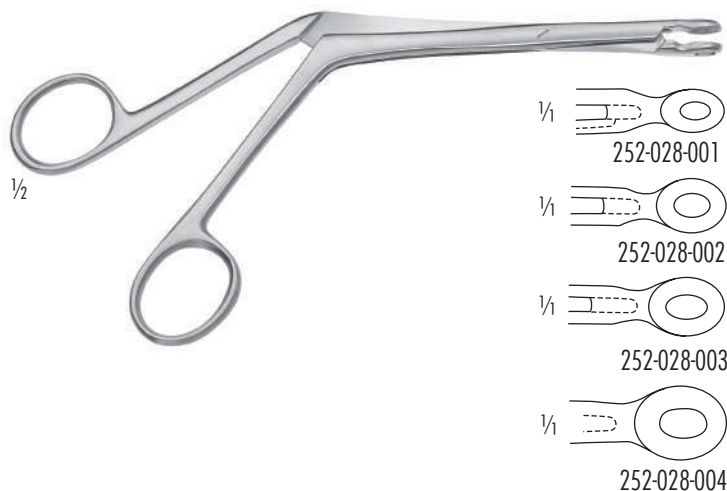

- 252-028-001 Größe/Size 1
- 252-028-002 Größe/Size 2
- 252-028-003 Größe/Size 3
- 252-028-004 Größe/Size 4

BRUENINGS

Septumzange, gefenstert, 190 mm
Septum forceps, fenestrated jaws, 7 1/2 inch

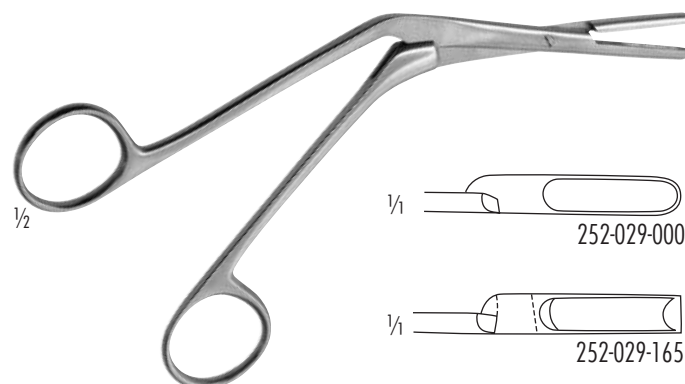

- 252-029-000 6mm

CRAIG

Vormerzange, gerade, scharfer Löffel oval, 165 mm
Septum bone cutting and breaking forceps straight, sharp cup, 6 1/2 inch

- 252-029-165 6mm

CRAIG

Vormerzange mit eckigen Schneidkanten, 165 mm
Septum bone cutting and breaking forceps straight, sharp cup, 6 1/2 inch

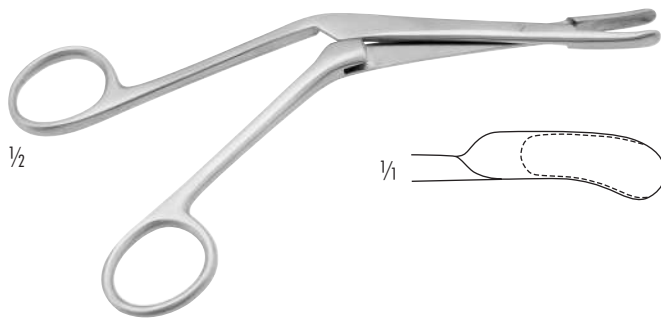

252-029-500
CRAIG-DOMNICK

Vormerzange, linksgebogen, scharfe Löffel, 165 mm
Septum bone cutting and breaking forceps, curved to the left, sharp cup, 6 1/2 inch

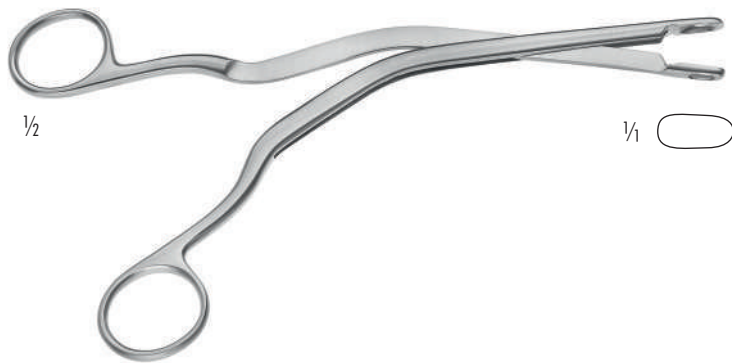

420-412-190
IRWIN MOORE

Septumzange, 190 mm
Septum forceps, 7 1/2 inch



420-422-190
HEYMANN-KNIGHT

Septumzange, scharfer ovaler Löffel, 190 mm
Septum forceps, with sharp oval cup, 7 1/2 inch

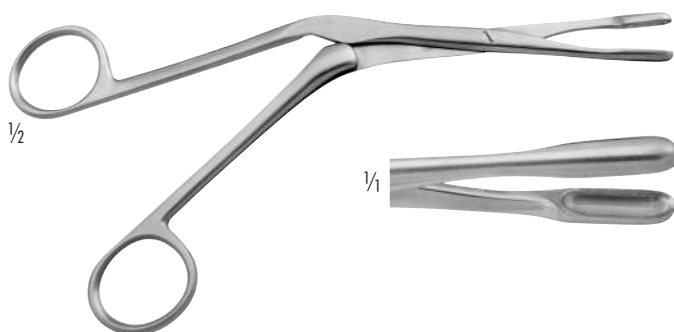

420-214-180
KNIGHT

Nasenzange, scharf, 180 mm
Nasal forceps, sharp, 7 inch



252-031-190 4x14 mm großes Modell / large pattern
 252-033-190 3x13 mm kleines Modell / small pattern
JANSEN-MIDDLETON
 Nasenzange, durchschneidend, 210 mm
 Nasal forceps, through cutting, 8 1/4 inch



252-032-190 4x11 mm
JANSEN-MIDDLETON
 Nasenzange, Löffelmaul, 170 mm
 Nasal forceps, cup-shaped, 6 3/4 inch



420-213-180
BECKER
 Septumschere mit Doppelgelenk, gezahnt, 180 mm
 Septum scissors, double action, with serrated jaws, 7 inch



120-286-220 gerade Schneide/straight cutting edge
CAPLAN
 Nasenschere, 220 mm
 Nasal scissors, 8 1/2 inch

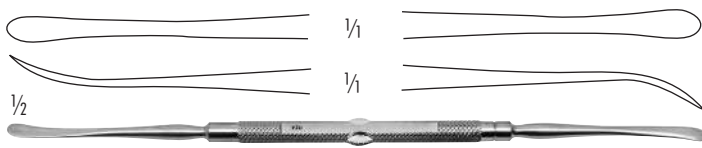

420-546-180 5 mm
FREER
 Elevatorium, scharf/stumpf, 185 mm
 Elevator, sharp /blunt, 7 1/4 inch

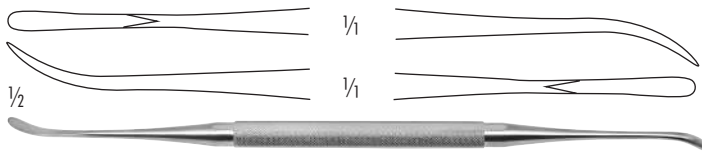

420-548-180
FREER-YASARGIL
 Dissektor, scharf, 190 mm
 Dissector, sharp, 7 1/2 inch



210-528-240
COHEN
 Elevator, doppelendig, 240mm
 Elevator, double-ended, 9 1/2 inch



420-556-200
WOODSON
 Elevator, 2,4 / 4,0mm Blatt, 200mm
 Elevator, 2.4 / 4.0mm blade, 8 inch



420-395-205 6 mm
NEGUS
 Saugdissektor, stumpf 210 mm
 Suction dissector, blunt, 8 1/4 inch



420-253-185 3 mm
GORNEY
 Saugraspatorium, halb-scharf 180 mm
 Suction raspatory, semi-sharp 7 inch

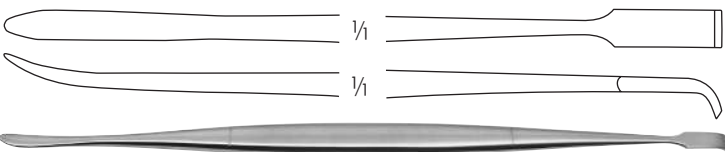

420-552-215
HOWARTH
 Doppel-Elevatorium, 215 mm
 Elevator, double-ended, 8 1/4 inch

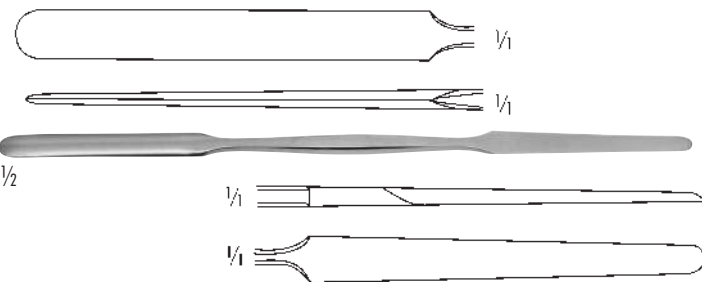

420-541-180
KILLIAN
 Doppel-Elevatorium, scharf/stumpf, 185 mm
 Elevator, double-ended, sharp/blunt, 7 1/4 inch

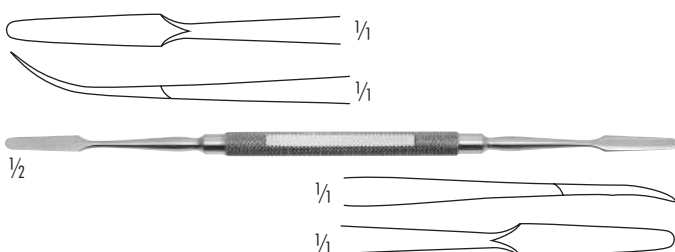

420-540-180
KILLIAN
 Doppel-Elevatorium, scharf/stumpf, 180 mm
 Elevator, double-ended, sharp/blunt, 7 inch



252-002-180

KILLIAN

Doppel-Elevatorium, schuppenförmig, scharf/stumpf, 180 mm
Septum double-ended elevator, shuffle-shaped, sharp/blunt, 7 inch



252-001-200

FREER

Doppel-Elevatorium, halbscharf/stumpf, 200 mm
Septum double-ended elevator, semi-sharp/blunt, 8 inch

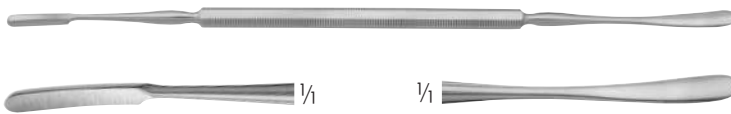

420-555-200

FREER-JOSEPH

Doppel-Elevatorium, 200 mm
Septum double-ended elevator, 8 inch



420-551-200

MASING

Elevatorium, doppelendig, graduiert, scharf/stumpf, 200 mm
Elevator, double-ended, graduated, sharp/blunt, 8 inch



420-550-230

COTTLE

Doppel-Elevatorium, graduiert, scharf/stumpf, 210 mm
Elevator, double-ended, graduated, sharp/blunt, 8 1/4 inch

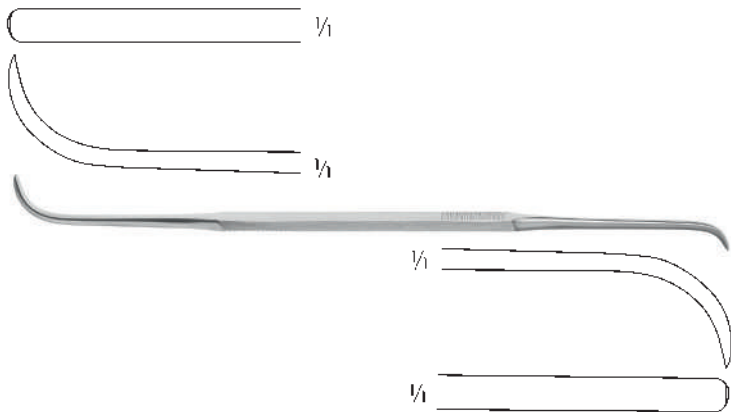

420-552-200

COTTLE

Doppel-Elevatorium, zum Tunnelieren, 220 mm
Elevator, double-ended, for tunneling, 9 inch

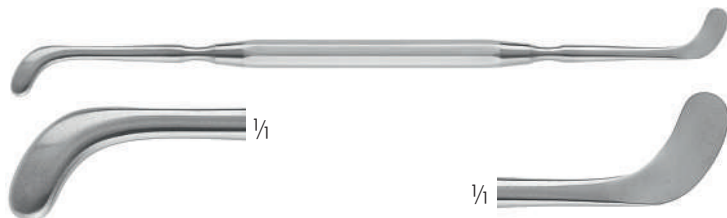

420-543-210

PENNINGTON

Elevatorium, 210 mm
Elevator, 8 1/4 inch

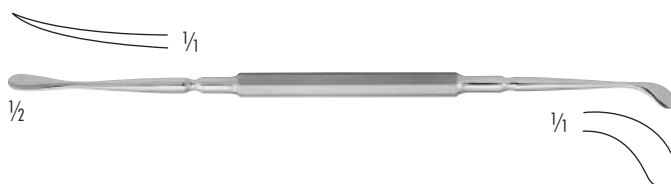

420-551-175

FREER

Raspatorium, doppelendig, scharf, 175 mm
Periosteal elevator, double-ended, sharp, 7 inch

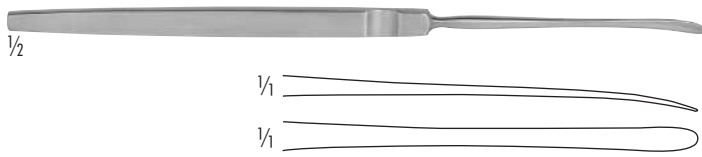

420-544-165 4,0 mm

HALLÉ

Elevatorium, stumpf, 180 mm
Elevator, blunt, 7 inch



420-551-180 4 mm

FREER

Raspatorium, 160 mm
Periosteal elevator, 6 1/2 inch



420-557-165 4,0 mm

Raspatorium, abgewinkelte Spitze, 165 mm
Periosteal elevator, angled tip, 6 1/2 inch



420-547-004 4 mm

420-547-005 5 mm

MC KENTY

Septum Elevatorium, gebogen, scharf, 155 mm
Septum periosteal elevator, curved, sharp, 6 inch



420-547-006

ERLANGEN

Raspatorium, 6mm breit, leicht gebogen, 175 mm
Raspatory, 6mm wide, slightly curved, 7 inch



- 420-392-003 3 mm
- 420-392-004 4 mm
- 420-392-005 5 mm

BALLENGER

Schwingmesser, bajonettförmig, 210 mm
Swivel knife, bayonet shaped, 8 1/4 inch

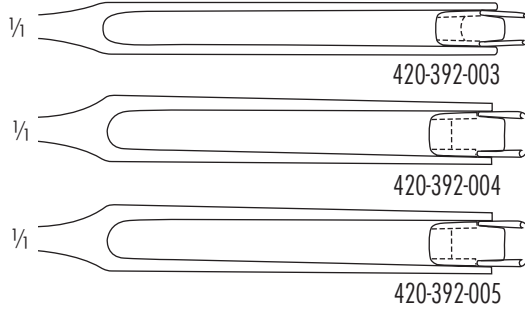

- 420-393-003 3 mm
- 420-393-004 4 mm
- 420-393-005 5 mm

BALLENGER

Schwingmesser, gerade, 195 mm
Swivel knife, straight, 8 inch

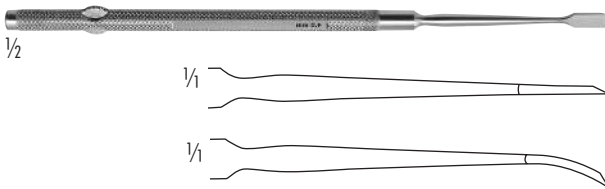

- 420-590-004 4 mm, gerade/straight
- 420-591-004 4 mm, gebogen/curved

FREER

Septum Flachmeissel, 160 mm
Septum chisel, 6 1/4 inch



- 420-550-170 6 mm

FREER

Septum-Hohlmeissel, mit runder Schneide, gerade, 150 mm
Septum gouge, straight, round cutting edge, 6 inch

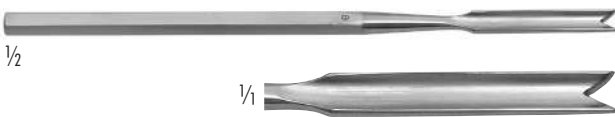

- 420-595-170 6 mm

BALLENGER

Septum-Hohlmeissel mit Kerbe, gerade, 155 mm
Septum gouge, with notch and cutting edge, 6 inch

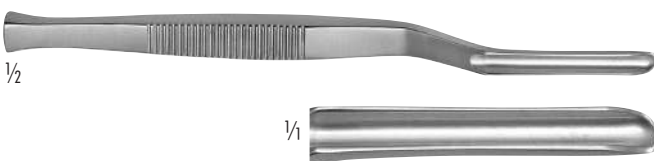

- 420-552-170 6 mm

KILLIAN

Septum-Hohlmeissel mit runder Schneide, bajonettförmig gebogen, 170 mm
Septum gouge, round cutting edge, bayonet shaped, 6 3/4 inch

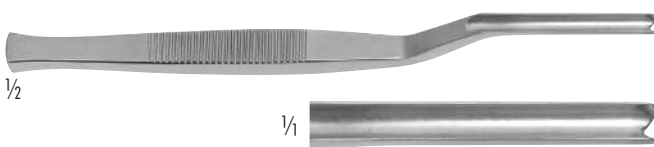

- 420-551-170 6 mm

KILLIAN-CLAUS

Septum-Hohlmeissel mit Kerbe, bajonettförmig gebogen, 170 mm
Septum gouge with notch, bayonet shaped, 6 3/4 inch



170-010-125
GRAEFE
 Hauthäkchen, scharf, 120 mm
 Skin hook, sharp, 4 3/4 inch



230-285-160
COTTLE
 Scharfes Sehnenhäkchen, 120° retrograd gebogen, 168 mm
 Tenaculum hook, 120° retrograde curved, 6 2/3 inch



230-286-160
COTTLE
 Scharfes Sehnenhäkchen, 180° retrograd gebogen, 168 mm
 Tenaculum hook, 180° retrograde curved, 6 2/3 inch



230-203-150
KILNER
 Hauthäkchen, scharf, 150 mm
 Skin hook, sharp, 6 inch

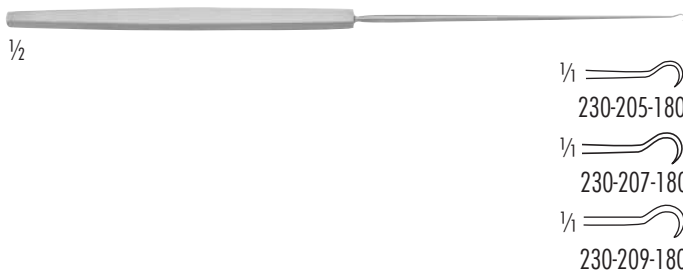

230-205-180 klein/small
 230-207-180 mittel/medium
 230-209-180 groß/large
GILLIES
 Hauthäkchen, scharf, 180 mm
 Skin hook, sharp, 7 inch



170-013-130 130 mm, 5 1/4 inch
 170-013-180 180 mm, 7 inch
FRAZIER
 Hauthäkchen, scharf
 Skin hook, sharp



250-064-376
FISCH
 Hauthäkchen, 90° abgewinkelt, scharf, 190 mm
 Skin hook, 90° angled, sharp, 7 1/2 inch



170-060-001 klein/small
 170-060-002 groß/large
CUSHING
 Stumpfes Häkchen, 190 mm
 Buttoned hook, 7 1/2 inch



170-042-130
GUTHRIE
 Hauthäkchen, Fig. 1, 120 mm
 Skin hook, Fig. 1, 4 3/4 inch



170-014-001

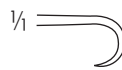

170-014-001

JOSEPH

Hauthäkchen, scharf, 1 Zinken, 150 mm
Skin hook, sharp, single prong, 6 inch

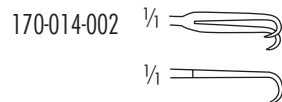

170-014-002

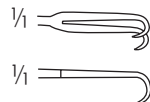

170-014-002 2 mm

170-014-005 5 mm

170-014-007 7 mm

170-014-010 10 mm

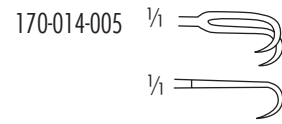

170-014-005

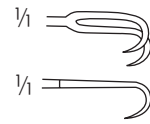

JOSEPH

Hauthäkchen, 2 Zinken, scharf, 160 mm
Skin hook, sharp, 2 prongs, 6 1/4 inch

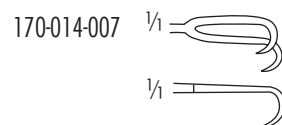

170-014-007

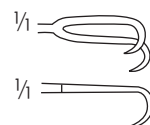

1/2



170-014-010

230-220-001

FREER

Hauthäkchen, 2 Zinken, scharf, 150 mm
Skin hook, 2 prongs, sharp, 6 inch



1/2

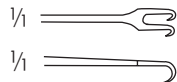

1/4

1/4

400-287-004 scharf/sharp

400-287-044 stumpf/blunt

ROLLET

Hauthäkchen, 4 Zinken, 135 mm
Skin hook, 4 prongs, 5 1/4 inch

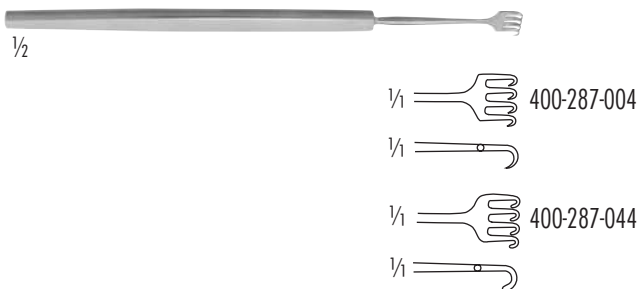

1/2



1/4

1/4

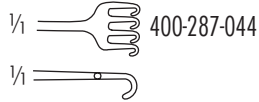

1/4

1/4

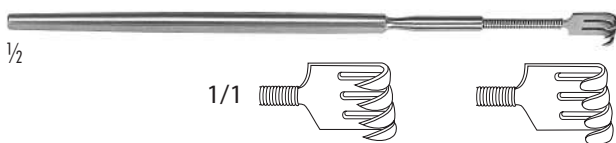

1/2

1/1

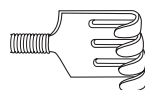
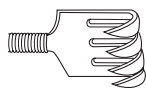

170-079-163 3 Zinken, scharf / 3 prongs, sharp

170-079-164 4 Zinken, scharf / 4 prongs, sharp

170-076-163 3 Zinken, stumpf / 3 prongs, blunt

170-076-164 4 Zinken, stumpf / 3 prongs, blunt

Feine Wundhaken mit flexibler Spitze, 160 mm

Fine hand held retractor with flexible tip, 6 1/4 inch

170-008-381

COTTLE

Wundhäkchen mit Ring, Arbeitslänge: 38 mm, scharf, 2-zahnig, 8 mm
Thumb retractor, working length 1 1/2 inch, sharp, double hook, 8 mm wide





420-186-145

FOMON

Nasenflügelretractor, 2 Zinken, stumpf/stumpf, 140 mm
Alar retractor, 2 prongs, blunt/blunt, 5 1/2 inch



230-281-140 stumpf/spitz, blunt/sharp

230-282-140 spitz/stumpf, sharp/blunt

COTTLE

Nasenflügelretractor, 2 Zinken, 140 mm
Alar retractor, 2 prongs, 5 1/2 inch

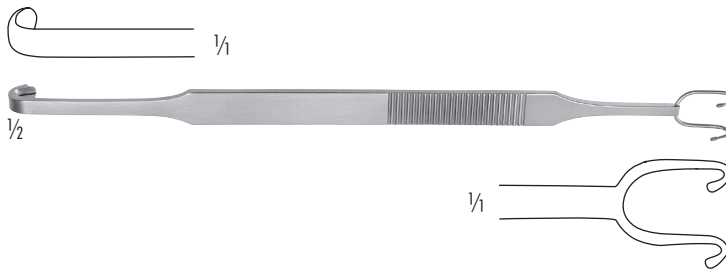

230-260-200

COTTLE-NEIVERT

Nasenflügelretractor, mit Säge- oder Messerführung,
2 Zinken, stumpf, 200 mm
Alar retractor, with saw and knife guide, 2 prongs, blunt, 8 inch

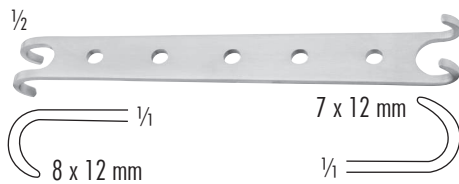

260-501-120

CONVERSE

Alar-Doppelhaken, 2 Zinken, stumpf/stumpf, 120 mm
Alar retractor, double-ended, 2 prongs, blunt/blunt, 4 3/4 inch



420-187-155 sharp

420-187-255 blunt

RUBIN

Haken, 7mm lang, 5,5mm breit
Hook, 7mm length, 5.5mm wide



420-524-150

COTTLE

Alar Retraktor mit Lippe, 150 mm
Alar retractor with lip, 6 inch



420-184-100 spitz/spitz / sharp/sharp

420-185-100 stumpf/stumpf / blunt/blunt

KILNER

Nasenflügelretractor, 2 Zinken, 85 mm
Alar retractor, 2 prongs, 3 1/4 inch

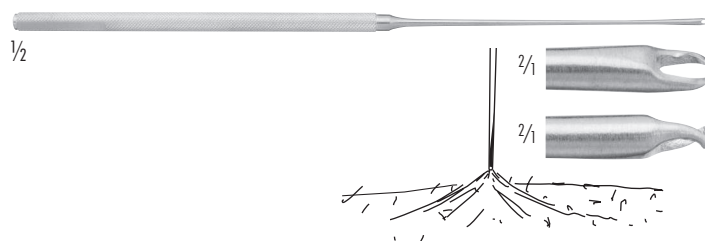

250-064-392 Ø 1,8 mm

Hautkralle mit Schutzkappe, 185 mm

Skin picks with protection cap, 7 1/4 inch



420-520-140



420-520-141

420-520-140 6x12 mm
 420-520-141 6x12 mm, **isoliert/insulated**
MASING

420-523-140 10x12 mm
 420-523-141 10x12 mm; **isoliert/insulated**
COTTLE

Alar Retraktor, 140 mm
 Alar retractor; 5 1/2 inch

420-256-135

WALTER

Doppelhaken, eine Seite mit 2 stumpfen Haken, eine Seite mit stumpfen Blatt

Double-ended retractor, one end 2 blunt prongs and one with blade



1/2

420-260-005 5mm + 42x7mm
 420-260-008 8mm + 38x7mm
 420-260-013 13mm + 38x7mm
 420-260-113 13mm + 42x10mm

AUFRICT

Doppelendiger Nasenhaken, stumpf
 Double-ended nasal retractor, blunt



420-250-160

420-251-160

420-250-160 10x45 mm Blatt/blade
 420-251-160 10x30 mm Blatt/blade

AUFRICT

Nasenretraktor, 160 mm
 Nasal retractor, 6 1/4 inch

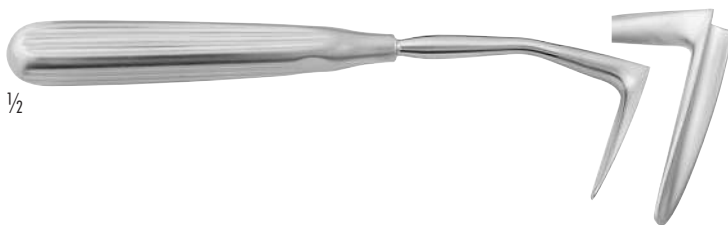

1/2

420-057-160

DEVINE-MILLARD-AUFRICT

Nasenretraktor, 10 x 45 mm Blatt, 180 mm
 Nasal retractor, 10 x 45 mm blade, 7 inch

420-257-160

Dito, mit KL-Anschluß
 Same, with fibre optic



detachable fibre optic

420-255-160

AUFRICT

Nasenretraktor, mit Kaltlicht, 120°, 45 mm Blatt, 180 mm
 Nasal retractor, with fibre optic, 120°, 45 mm blade, 7 inch



1/2

420-652-100

420-752-100 mit Kaltlichtträger/with fibre optic light carrier

MALINIAC

Nasenretraktor, 9 x 45 mm, 100 mm
 Nasal retractor, 9 x 45 mm, 4 inch



1/2

420-236-110 11 x 44 mm

CONVERSE

Nasenretraktor, mit Kaltlicht, 110 mm
 Nasal retractor, with fibre optic, 4 1/3 inch



- 230-202-000 gerade/straight
- 230-202-001 bajonettförmig, links gebogen
bayonet shaped, curved to the left
- 230-202-002 bajonettförmig, rechts gebogen
bayonet shaped, curved to the right

JOSEPH
Nasensäge, 170 mm
Nasal saw, 6 3/4 inch



- 230-211-170 links abgewinkelt/left angled
- 230-210-170 rechts abgewinkelt/right angled

JOSEPH
Nasensäge, 170 mm
Nasal saw, 6 3/4 inch



- 420-605-160 fein kariert/fine cross-serrated
- 420-606-160 grob kariert/coarse cross-serrated

JOSEPH
Raspel, zum Füllen von nasalen Knochen, 165 mm
Rasp, for filling nasal bone material, 6 1/2 inch

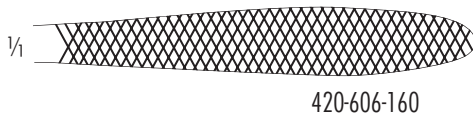
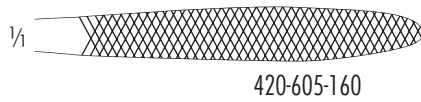

420-653-180

MALTZ
Nasen-Raspel, 90° quer gerieft, auf Zug schneidend, 180 mm
Nasal rasp, 90° cross-serrated, teeth set to cut on down stroke, 7 inch



420-650-001

AUFRICHT
Nasen-Raspel, 90° quer gerieft, auf Zug schneidend, 220 mm
Nasal rasp, 90° cross-serrated, teeth set to cut on down stroke, 8 3/4 inch



420-700-400
NOLST TRENIÉ
 Glabella Rasp, 8mm breit, 185mm
 Glabella Rasp, 8mm wide, 185mm



420-700-501 medium
 420-700-502 medium/fine
NOLST TRENIÉ
 Nasen Rasp, doppelendig, TC Einsätze, 200mm
 Nasal Rasp, double ended, TC Inserts, 200mm



420-700-001 1 Zahn / 1 prong
 420-700-002 2 Zähne / 2 prongs
NOLST TRENIÉ
 Mikro Hauthäkchen, 155mm
 Micro Skin Hook, 155mm



420-700-210
NOLST TRENIÉ
 Mikro Hauthäkchen, 2 Zähne, 10mm breit
 Micro Skin Hook, 2 prongs, 10mm wide



420-700-200
NOLST TRENIÉ
 Aufricht Nasen Retraktor, 160mm
 Aufricht Nasal Retractor, 160mm



420-700-020 2.0mm
 420-700-025 2.5mm
 420-700-030 3.0mm
 420-700-040 4.0mm
 420-700-060 6.0mm
NOLST TRENIÉ
 Mikro Osteotom
 Micro Osteotome